

# LABORATUVAR CAM MALZEMELERİ



**BORU CAM**

**2018 Katalog  
Catalog**



[www.borucam.com.tr](http://www.borucam.com.tr)

▶▶ GENEL LABORATUVAR MALZEMELERİ GENERAL LABORATORY SUPPLIES	01
▶▶ BEHER - BALON - ERLEREN BEHR - BALLOON - ERLAN	02
▶▶ ŞİLİFLİ BALON - ERLEREN ŞİLİFL BALLOON - ERLAN	03
▶▶ ÇOK BOYUNLU BALONLAR MANY BALLOONS NECK	04
▶▶ KJELDAHL VE DİSTİLASYON BALONU KJELDAHL AND DISTILLATION FLASK	05
▶▶ REAKSİYON BALONU REACTION FLASK	06
▶▶ KARIŞTIRICI VE KARIŞTIRICI YATAĞI MIXER AND MIXING BED	07
▶▶ DESİKATÖR VE ŞİŞELER DESICCATOR AND BOTTLES	08
▶▶ AYIRMA HUNİLERİ SEPERATION FUNNELS	09-10
▶▶ SOĞUTUCULAR COOLERS	11
▶▶ FİLTRASYON ALETLERİ FILTRATION APPARATUS	12-13
▶▶ VACUM TRAP VACUM TRAP	14
▶▶ VOLÜMETRİK ÜRÜNLER VOLUMETRIC PRODUCTS	15-16-17 18-19
▶▶ TÜPLER TUBES	20-21-22
▶▶ KOLONLAR COLUMNS	23-24
▶▶ BAĞLANTI PARÇALARI FITTINGS	25-26-27 28-29
▶▶ ALETLER TOOLS	30-31-32 33
▶▶ CAM BORULAR GLASS TUBES	34-35
▶▶ METAL MALZEMELER METAL MATERIALS	36-37-38 39

### BORUCAM LABORATUAR MALZEMELERİ SANAYİ ve TİC.LTD.ŞTİ.

Borucam 1972 yılından beri cam laboratuvar malzemelerinin tanınmış bir üreticisidir. Deneyimimiz, ürün inovasyonumuz ve yaptığımız geliştirmelerle müşterilerimizin işlerini kolaylaştırmaktayız. En modern üretim teknolojilerini kullanan, yetkin, deneyimli işçilerden oluşan uzman bir ekibimiz bulunmaktadır.

Bizim için büyük önem verdiğimiz hizmet konusunda: siparişleri verimli şekilde ele almak, sorularınıza hızlı cevap vermek, hızlı teslimat ve geniş kapsamlı ürün yelpazemiz ile sizlere en iyi hizmeti vermeyi kendimize ilke edinmişizdir.

Sorunlarınızı ve ihtiyaçlarınızı tecrübemiz ile en kısa zamanda çözüme kavuşturamaktayız.

Bu durum Cam Laboratuvar malzemeleri sektöründeki en iyi ve en deneyimli üreticilerden birisi olmamızı sağlamaktadır.

Borucam since 1972, it is a well-known manufacturer of glass laboratory equipment . Our experience kolaylaştırmakt we work with our customers we develop products and our inovasyonu . Using the most modern production technologies, competent, we have a team of experienced professionals working there .

In the service we give great importance for us: take orders efficiently , your questions give quick answers to you with our extensive range of products, fast delivery and provide the best service It is Dr conduct ourselves.

Our problems and experiences , we need to clarify en solution as soon as possible .

One of the best and most experienced manufacturers in this case, glass laboratory equipment sector It enables us to be .

### KALİTE POLİTİKAMIZ/QUALITY POLICY

- ▶ Borucam Laboratuvar Malzemeleri Sanayi ve Tic. Ltd. Şti. nin temel politikası; Müşteri taleplerine en kısa zamanda ve en üst düzeyde cevap vermektir.
- ▶ Borucam Laboratuvar Malzemeleri Sanayi ve Tic. Ltd. Şti. the basic policy ; Customer demand is to give answers as soon as possible and at the highest level.
- ▶ Bu politikayı gerçekleştirmek için; Sürekli eğitim ve bilinçlendirme faaliyetleri ile çalışanlarımızın en üst düzeyde sisteme katılımını sağlamayı,
- ▶ To perform this policy; Participation in the system at the highest level of our employees through continuous training and awareness activities providing,
- ▶ Ürün kalitesi, teslim süresi ve satış sonrası hizmetlerde en üst düzeye ulaşmayı, Kalite Yönetim Sistemini sürekli geliştirmeyi ve iyileştirmeyi taahhüt eder.
- ▶ Product quality, delivery time and after-sales service to reach the highest level , Quality Management System is committed to continuous development and improvement .



## SERTİFİKA

Bu Sertifika,

### **BORUCAM LABORATUAR VE İNŞAAT MALZEMELERİ SANAYİ VE TİCARET LİMİTED ŞİRKETİ**

İncirlik Sokak No: 17 / 3 Topçular, Eyüp / İstanbul / Türkiye

kuruluşunun,

**LABORATUAR MALZEMELERİ ÜRETİMİ**

**EA 15**

kapsamında,

### **ISO 9001:2008**

Kalite Yönetim Sistemi standardının şartlarına uyan bir yönetim sistemi kurduğunu ve uyguladığını onaylamak üzere verilmiştir.

**İlk Veriliş Tarihi : 24.03.2011**  
**Belge Tarihi : 23.03.2013**  
**Belge Periyodu : 3 Yıl**  
**Bitiş Tarihi : 23.03.2014**  
**Sertifika No : 01.11.2303.7191.D**

First Quality Certification  
Sistem Sertifikasyon Onayı  
**İstanbul / 2013.03.23**



TGA-ZM-13-08-00



## GENEL LABORATUVAR MALZEMELERİ

### GENERAL LABORATORY SUPPLIES

- ▶▶ **BEHER - BALON - ERLEREN**  
BEHR - BALLOON - ERLAN
- ▶▶ **ŞİLİFLİ BALON - ŞİLİFLİ ERLEREN**  
ŞİLİFL BALLOON - ŞİLİFL ERLAN
- ▶▶ **ÇOK BOYUNLU BALONLAR**  
MANY BALLOONS NECK
- ▶▶ **KJELDAHL VE DİSTİLASYON BALONU**  
KJELDAHL AND DISTILLATION FLASK
- ▶▶ **REAKSİYON BALONU**  
REACTION FLASK
- ▶▶ **KARIŞTIRICI VE KARIŞTIRICI YATAĞI**  
MIXER AND MIXING BED
- ▶▶ **DESİKATÖR VE ŞİŞELER**  
DESICCATOR AND BOTTLES

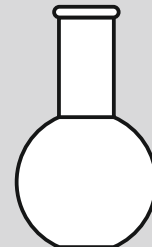
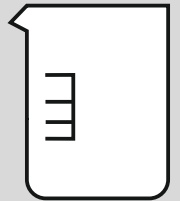
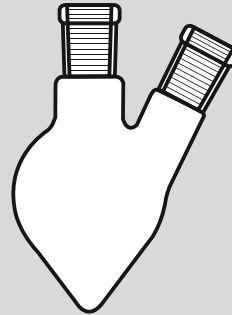
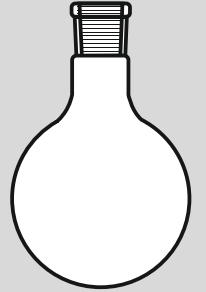
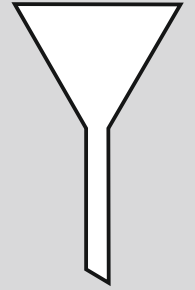
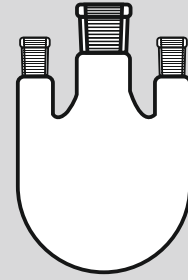
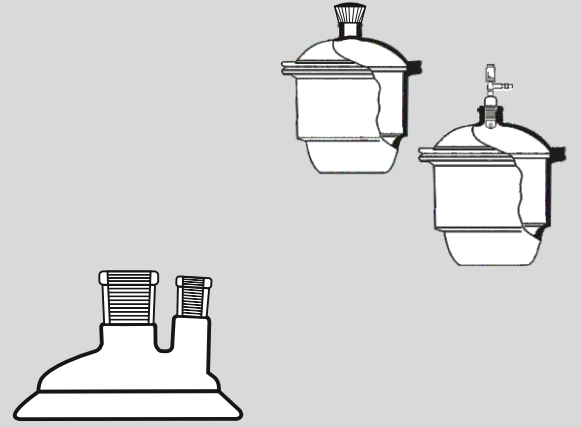

**Beher**Kısa Form  
Dereceli

Katalog No.	Hacim/ml	Çap/mm	Yükseklik/mm
05 001 - 00010	10	26	35
05 001 - 00025	25	34	50
05 001 - 00050	50	42	60
05 001 - 00100	100	50	70
05 001 - 00150	150	60	80
05 001 - 00250	250	70	95
05 001 - 00400	400	80	110
05 001 - 00600	600	90	125
05 001 - 00800	800	100	135
05 001 - 01000	1000	105	145
05 001 - 02000	2000	132	185
05 001 - 03000	3000	152	210
05 001 - 05000	5000	170	270
05 001 - 10000	10000	217	350

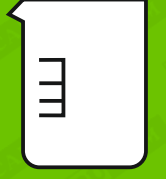
**Erlen, Dar Boyunlu**

Dereceli

Katalog No.	Hacim/ml	Çap/mm	Yükseklik/mm	Boyun/mm
05 003 - 00025	25	42	75	22
05 003 - 00050	50	51	90	22
05 003 - 00100	100	64	105	22
05 003 - 00150	150	74	120	22
05 003 - 00250	250	85	145	34
05 003 - 00300	300	87	156	34
05 003 - 00500	500	105	180	34
05 003 - 01000	1000	131	220	50
05 003 - 02000	2000	166	280	50
05 003 - 03000	3000	187	310	50
05 003 - 05000	5000	220	365	50

**Erlen, Geniş Boyunlu**

Dereceli

Katalog No.	Hacim/ml	Çap/mm	Yükseklik/mm	Boyun/mm
05 006 - 00050	50	51	85	34
05 006 - 00100	100	64	105	34
05 006 - 00150	150	74	120	34
05 006 - 00250	250	85	140	50
05 006 - 00300	300	87	156	50
05 006 - 00500	500	105	175	50

**Balon**Dibi Düz  
Dibi Yuvarlak

DİBİ DÜZ Katalog No.	DİBİ YUVARLAK Katalog No.	Hacim ml	Çap mm	Yükseklik mm
05 010 - 00025	05 020 - 00025	25	42	75
05 010 - 00050	05 020 - 00050	50	51	95
05 010 - 00100	05 020 - 00100	100	64	110
05 010 - 00150	05 020 - 00150	150	74	135
05 010 - 00250	05 020 - 00250	250	85	144
05 010 - 00500	05 020 - 00500	500	105	175
05 010 - 01000	05 020 - 01000	1000	131	200
05 010 - 02000	05 020 - 02000	2000	166	260
05 010 - 03000	05 020 - 03000	3000	185	260
05 010 - 04000	05 020 - 04000	4000	207	315
05 010 - 05000	05 020 - 05000	5000	223	315
05 010 - 06000	05 020 - 06000	6000	236	355
05 010 - 10000	05 020 - 10000	10000	279	420
05 010 - 20000	05 020 - 20000	20000	345	515

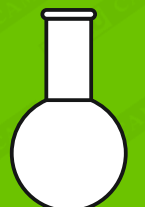

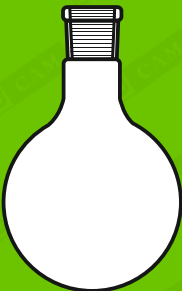
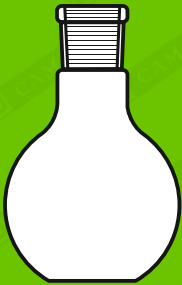
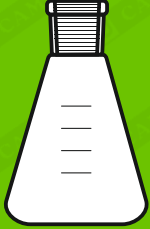

Katalog No.	Hacim/ml	Boyun/NS
05 004 - 00025	25	14/23
05 004 - 00050	50	14/23
05 004 - 00100	100	14/23
05 005 - 00025	25	19/26
05 005 - 00050	50	19/26
05 005 - 00100	100	19/26
05 005 - 00150	150	19/26
05 005 - 00250	250	19/26
05 007 - 00050	50	29/32
05 007 - 00100	100	29/32
05 007 - 00150	150	29/32
05 007 - 00250	250	29/32
05 007 - 00300	300	29/32
05 007 - 00500	500	29/32
05 007 - 01000	1000	29/32
05 007 - 02000	2000	29/32
05 007 - 03000	3000	29/32
05 008 - 01000	1000	45/40
05 008 - 02000	2000	45/40
05 008 - 03000	3000	45/40
05 008 - 05000	5000	45/40

**Erlen**  
Şilifli

Katalog No.	Hacim/ml	Boyun/NS
01 009 - 00100	100	19/26
01 009 - 00250	250	29/32
01 009 - 00300	300	29/32
01 009 - 00500	500	29/32

**İyot Erlen**

DİBİ DÜZ Katalog No.	DİBİ YUVARLAK Katalog No.	Hacim ml	Boyun NS
05 011 - 00025	05 021 - 00025	25	14/23
05 011 - 00050	05 021 - 00050	50	14/23
05 011 - 00100	05 021 - 00100	100	14/23
05 012 - 00025	05 022 - 00025	25	19/26
05 012 - 00050	05 022 - 00050	50	19/26
05 012 - 00100	05 022 - 00100	100	19/26
05 012 - 00150	05 022 - 00150	150	19/26
05 012 - 00250	05 022 - 00250	250	19/26
05 014 - 00050	05 024 - 00050	50	29/32
05 014 - 00100	05 024 - 00100	100	29/32
05 014 - 00150	05 024 - 00150	150	29/32
05 014 - 00250	05 024 - 00250	250	29/32
05 014 - 00500	05 024 - 00500	500	29/32
05 014 - 01000	05 024 - 01000	1000	29/32
05 014 - 02000	05 024 - 02000	2000	29/32
05 014 - 03000	05 024 - 03000	3000	29/32
05 014 - 04000	05 024 - 04000	4000	29/32
05 014 - 05000	05 024 - 05000	5000	29/32
05 014 - 06000	05 024 - 06000	6000	29/32
05 015 - 01000	05 025 - 01000	1000	45/40
05 015 - 02000	05 025 - 02000	2000	45/40
05 015 - 03000	05 025 - 03000	3000	45/40
05 015 - 04000	05 025 - 04000	4000	45/40
05 015 - 05000	05 025 - 05000	5000	45/40
05 015 - 06000	05 025 - 06000	6000	45/40
05 015 - 10000	05 025 - 10000	10000	45/40
05 015 - 20000	05 025 - 20000	20000	45/40

**Balon**  
Şilifli

Dibi Düz

Dibi Yuvarlak

**Balon**

İki Boyunlu  
Dibi Yuvarlak

Katalog No.	Hacim/ml	Orta Boyun/NS	Yan Boyun/NS
01 032 - 00050	50	19/26	14/23
01 032 - 00100	100	19/26	14/23
01 032 - 00250	250	29/32	14/23
01 032 - 00500	500	29/32	14/23
01 032 - 01000	1000	29/32	14/23
01 032 - 02000	2000	29/32	29/32
01 032 - 03000	3000	29/32	29/32
01 032 - 04000	4000	29/32	29/32
01 032 - 05000	5000	29/32	29/32
01 032 - 06000	6000	29/32	29/32
01 032 - 10000	10000	29/32	29/32

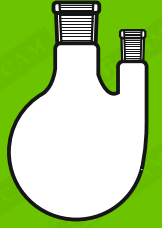

**Balon**

Üç Boyunlu  
Dibi Yuvarlak

Katalog No.	Hacim/ml	Orta Boyun NS	Yan Boyun NS	Yan Boyun NS
01 033 - 00050	50	29/32	14/23	14/23
01 033 - 00100	100	29/32	14/23	14/23
01 033 - 00250	250	29/32	14/23	14/23
01 033 - 00500	500	29/32	14/23	14/23
01 033 - 01000	1000	29/32	14/23	14/23
01 033 - 02000	2000	29/32	29/32	14/23
01 033 - 03000	3000	29/32	29/32	14/23
01 033 - 04000	4000	29/32	29/32	14/23
01 033 - 05000	5000	29/32	29/32	14/23
01 033 - 06000	6000	29/32	29/32	14/23
01 033 - 10000	10000	29/32	29/32	14/23

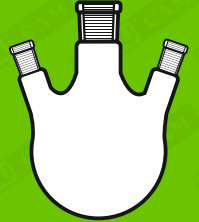
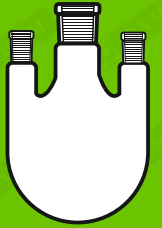

**Balon**

Dört Boyunlu  
Dibi Yuvarlak

Katalog No.	Hacim ml	Orta Boyun NS	Y.Boyun NS	Y.Boyun NS	Y.Boyun NS
01 034 - 00250	250	29/32	14/23	29/32	29/32
01 034 - 00500	500	29/32	14/23	29/32	29/32
01 034 - 01000	1000	29/32	14/23	29/32	29/32
01 034 - 02000	2000	29/32	14/23	29/32	29/32
01 034 - 03000	3000	29/32	29/32	29/32	29/32
01 034 - 04000	4000	29/32	29/32	29/32	29/32
01 034 - 05000	5000	29/32	29/32	29/32	29/32
01 034 - 06000	6000	29/32	29/32	29/32	29/32
01 034 - 10000	10000	29/32	29/32	29/32	29/32

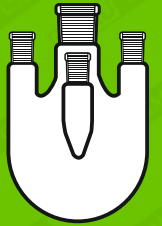

**Balon**

Beş Boyunlu  
Dibi Yuvarlak

Katalog No.	Hacim ml	O.Boyun NS	Y.Boyun NS	Y.Boyun NS	Y.Boyun NS	Y.Boyun NS
01 035 - 01000	1000	29/32	14/23	29/32	29/32	29/32
01 035 - 02000	2000	29/32	14/23	29/32	29/32	29/32
01 035 - 03000	3000	29/32	14/23	29/32	29/32	29/32
01 035 - 04000	4000	29/32	14/23	29/32	29/32	29/32
01 035 - 05000	5000	29/32	29/32	29/32	29/32	29/32
01 035 - 06000	6000	29/32	29/32	29/32	29/32	29/32
01 035 - 10000	10000	29/32	29/32	29/32	29/32	29/32

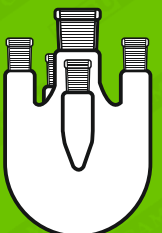

\* İki, üç, dört ve beş boyunlu dibi yuvarlak balonlarda Şilif ve boyunları isteğe göre yapılır.





Katalog No.	Hacim/ml	Boyun/NS
01 028 - 00100	100	35/20
01 028 - 00250	250	35/20
01 028 - 00500	500	35/20
01 028 - 01000	1000	35/20
01 028 - 02000	2000	35/20

**Balon**

Küresel Şilifli  
Dibi Yuvarlak

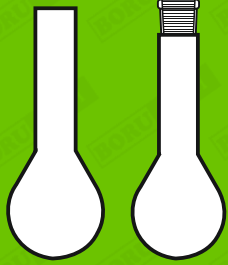

ŞİLİFSİZ Katalog No.	ŞİLİFLİ Katalog No.	Hacim ml	Çap mm	Boy mm	Boyun NS
01 050 - 00050	01 051 - 00050	50	51	200	22
01 050 - 00100	01 051 - 00100	100	49	200	22
01 050 - 00250	01 051 - 00250	250	60	270	34
01 050 - 00500	01 051 - 00500	500	81	300	34
01 050 - 00750	01 051 - 00750	750	101	340	34
01 050 - 01000	01 051 - 01000	1000	115	350	34
01 050 - 02000	01 051 - 02000	2000	126	-	34

**Kjeldahl Balonu**

Şilifsiz  
Şilifli



Katalog No.	Hacim/ml	Çap/mm	Boyun/mm	Yükseklik/mm
01 055 - 00100	100	63	22	150
01 055 - 00250	250	85	34	200
01 055 - 00500	500	105	34	250
01 055 - 01000	1000	131	34	300

**Distilasyon Balonu**



Katalog No.	Hacim/ml	Çap/mm	Boyun/mm	Yükseklik/mm
01 056 - 00100	100	66	16	215
01 056 - 00125	125	68	17	215
01 056 - 00150	150	73	16	223

**Engler Distilasyonu Balonu**

Şilifsiz

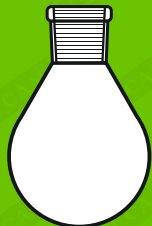

Katalog No.	Hacim/ml	Çap/mm	Boy/mm	Boyun/NS
01 060 - 00053	50	51	90	29/32
01 060 - 00103	100	60	110	29/32
01 060 - 00250	250	81	140	29/32
01 060 - 00500	500	101	170	29/32
01 060 - 01000	1000	126	210	29/32
01 060 - 02000	2000	160	235	29/32

**Rotapavör Balonu**



Katalog No.	Hacim/ml	Çap/mm	Boy/mm	Boyun/NS
01 062 - 14010	10	33	70	14/23
01 062 - 14025	25	43	90	14/23
01 062 - 14050	50	51	100	14/23
01 062 - 14100	100	64	120	14/23
01 062 - 19050	50	51	100	19/26
01 062 - 19100	100	64	120	19/26

**Balon**

Kalp Tipi  
Şilifli

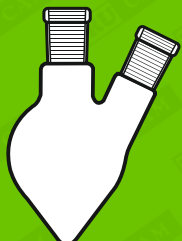

Katalog No.	Hacim/ml	Orta Boyun/NS	Yan Boyun/NS
01 063 - 00010	10	14/23	14/23
01 063 - 00025	25	14/23	14/23
01 063 - 00050	50	14/23	14/23
01 063 - 00100	100	14/23	14/23
01 063 - 00250	250	19/26	14/23

**Balon**

Kalp Tipi  
İki Boyunlu

**Reaksiyon Balonu**  
Düz Şilifli

Katalog No.	Hacim/ml	Çap/mm	Boy/mm	Flanş/DN
01 040 - 01000	1000	130	155	100
01 040 - 02000	2000	165	215	100
01 040 - 03000	3000	185	230	100
01 040 - 04000	4000	206	265	100
01 040 - 06000	6000	236	295	100
01 040 - 10000	10000	297	310	100



**Silindirik Reaksiyon Kabı**  
Düz Şilifli

Katalog No.	Hacim/ml	Çap/mm	Boy/mm	Flanş/DN
01 039 - 00500	500	106	120	100
01 039 - 01000	1000	105	205	100
01 039 - 02000	2000	140	270	100



**Reaktör Kapağı**  
Düz Şilifli

Katalog No.	Kapak/DN	Orta Boyun/NS	Boyunlar
01 041 - 00160	60	29/32	Tek Boyunlu
01 041 - 00260	60	29/32	İki Boyunlu
01 041 - 00360	60	29/32	Üç Boyunlu
01 041 - 00460	60	29/32	Dört Boyunlu
01 041 - 00560	60	29/32	Beş Boyunlu
01 042 - 01100	100	29/32	Tek Boyunlu
01 042 - 02100	100	29/32	İki Boyunlu
01 042 - 03100	100	29/32	Üç Boyunlu
01 042 - 04100	100	29/32	Dört Boyunlu
01 042 - 05100	100	29/32	Beş Boyunlu
01 044 - 01150	150	29/32	Tek Boyunlu
01 044 - 02150	150	29/32	İki Boyunlu
01 044 - 03150	150	29/32	Üç Boyunlu
01 044 - 04150	150	29/32	Dört Boyunlu
01 044 - 05150	150	29/32	Beş Boyunlu

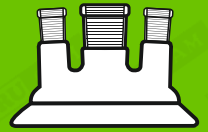

\* Şilif ve boyunları isteğe göre yapılır.

**Reaktör Kelepçesi**

Katalog No.	Boy/DN
01 045 - 00060	60
01 045 - 00100	100
01 045 - 00120	120
01 045 - 00150	150



**Silindirik Reaksiyon Kabı**  
Ceketli

Katalog No.	Hacim ml	Dış Çap mm	İç Çap mm	Yükseklik mm	Flanş DN
01 046 - 00500	500	130	100	260	100
01 046 - 01000	1000	130	100	390	100
01 046 - 02000	2000	150	120	290	100
01 046 - 03000	3000	190	150	350	100
01 046 - 05000	5000	190	150	450	100



**Silindirik Reaksiyon Kabı**  
Ceketli  
Musluklu

Katalog No.	Hacim ml	Dış Çap mm	İç Çap mm	Yükseklik mm	Flanş DN
01 047 - 00500	500	130	100	260	100
01 047 - 01000	1000	130	100	390	100
01 047 - 02000	2000	150	120	290	120
01 047 - 03000	3000	190	150	350	150
01 047 - 05000	5000	190	150	500	150

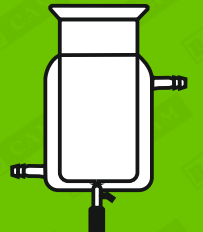

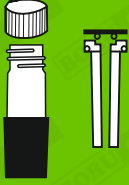

Katalog No.	Delik Çapı/mm	Şilif/NS
01 070 00002	6	19/26
01 070 00003	6	29/32
01 070 00012	10	29/32
01 070 00013	10	45/40

**Karıştırıcı Yatağı**

Civa Salmastralı

Katalog No.	Çap/mm	Şilif/NS
01 070 10029	6	29/32
01 070 20029	8	29/32
01 070 30029	10	29/32

**Teflon Karıştırıcı Yatağı**

Vidalı Adaptörü

ÇAPALI Katalog No.	AÇIILIR KANATLI Katalog No.	TEFLON KANATLI Katalog No.	Çap mm	Boy mm
01 071 - 00001	01 072 - 00001	01 073 - 00001	6	450
01 071 - 00002	01 072 - 00002	01 073 - 00002	6	600
01 071 - 00003	01 072 - 00003	01 073 - 00003	10	750

**Karıştırıcı Şaftı**

Çapalı

Açılır Kanatlı

Teflon Kanatlı

Katalog No.	Çap/mm	Şilif/NS
01 075 - 00001 YATAK	10	HB 10 YATAK 29/32
01 075 - 00002 YATAK	16	HB 16 YATAK 29/32
01 076 - 00001 ŞAFT	10	WB 10 ŞAFT Teflon Kanatlı
01 076 - 00002 ŞAFT	16	WB 16 ŞAFT Teflon Kanatlı

**Kpg Karıştırıcı**

Katalog No.	Şilif/NS
01 078 - 00080	14/23
01 078 - 00100	14/23
01 078 - 00120	14/23
01 078 - 00150	14/23

**Termometre Yuvası**

Katalog No.	ÇapxBoy/mm	ÇapxBoy/mm	
05 725 - 04025	40x25	40x25	KISA FORM
05 725 - 05030	50x30	50x30	KISA FORM
05 725 - 08035	80x35	80x35	KISA FORM
05 726 - 02540	25X40	25X40	UZUN FORM
05 726 - 03050	30X50	30X50	UZUN FORM

**Vezein Kabı**

Kısa Form

Uzun Form

Katalog No.	Hacim/ml	Çap/mm	Boy
01 163 - 00001	3	22	85
01 163 - 00002	6	28	105
01 163 - 00003	10	32	125

**Tartım Kaşığı**

Katalog No.	Çap/mm
05 740 - 00040	40
05 740 - 00050	50
05 740 - 00060	60
05 740 - 00075	75
05 740 - 00090	90
05 740 - 00100	100
05 740 - 00120	120
05 740 - 00150	150

**Huni**

Kısa Saplı

## Cam Havan

Tokmaklı

Katalog No.	İç Çap/mm
05 735 - 00090	90
05 735 - 00120	120
05 735 - 00150	150
05 735 - 00180	180

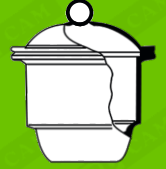

## Desikatör

Vakumsuz Katalog No.	Vakumlu Katalog No.	Çap/mm
05 770 - 00210	05 770 - 00210	240
05 770 - 00240	05 770 - 00240	240
05 770 - 00300	05 770 - 00300	300

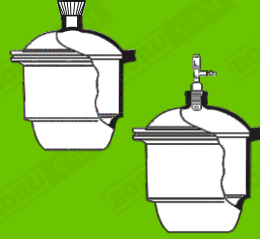

## Saat Camı

Katalog No.	Çap/mm
05 721 - 00060	60
05 721 - 00080	80
05 721 - 00100	100
05 721 - 00120	120
05 721 - 00150	150



## TLC Tankı

Cam Kapaklı

Katalog No.	En/mm	Boy/mm	Yükseklik/mm
05 750 - 00001	10	240	210

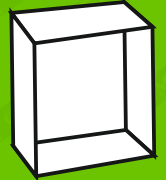

## Lam Boyama Kabı

Katalog No.	Çap/mm
05 780 - 00001	Dik Şale - Hellendahl
05 780 - 00002	Yatık Şale - Schiefferdecker
05 780 - 00003	Şale - Coplin

## Vida Kapaklı Şişe

Şeffaf renk

Amber renk

Şeffaf Katalog No.	Amber Katalog No.	Hacim ml	Çap mm	Yükseklik mm	Kapak GL
05 758 - 00100	05 759 - 00100	100	56	100	45
05 758 - 00250	05 759 - 00250	250	70	138	45
05 758 - 00500	05 759 - 00500	500	86	176	45
05 758 - 01000	05 759 - 01000	1000	101	225	45



## Cam Kapaklı Şişe

Şeffaf renk

Amber renk

Şeffaf Katalog No.	Amber Katalog No.	Hacim ml	Çap mm	Yükseklik mm
05 760 - 00060	05 761 - 00060	60	46	85
05 760 - 00125	05 761 - 00125	125	57	110
05 760 - 00250	05 761 - 00250	250	70	135
05 760 - 00500	05 761 - 00500	500	85	172
05 760 - 01000	05 761 - 01000	1000	106	202



## Aspiratör Şişesi

Şilifli

Musluklu

Şeffaf Katalog No.	Hacim ml	Çap mm	Yükseklik mm
05 097 - 01000	1000	110	200
05 097 - 02000	2000	145	270
05 097 - 05000	5000	185	338
05 097 - 10000	10000	225	430
05 097 - 20000	20000	265	520





## AYIRMA HUNİLERİ SEPERATION FUNNELS

▶▶ **AYIRMA HUNİLERİ**  
SEPERATION FUNNELS

▶▶ **SOĞUTUCULAR**  
COOLERS

▶▶ **FİLTASYON ALETLERİ**  
FILTRATION APPARATUS

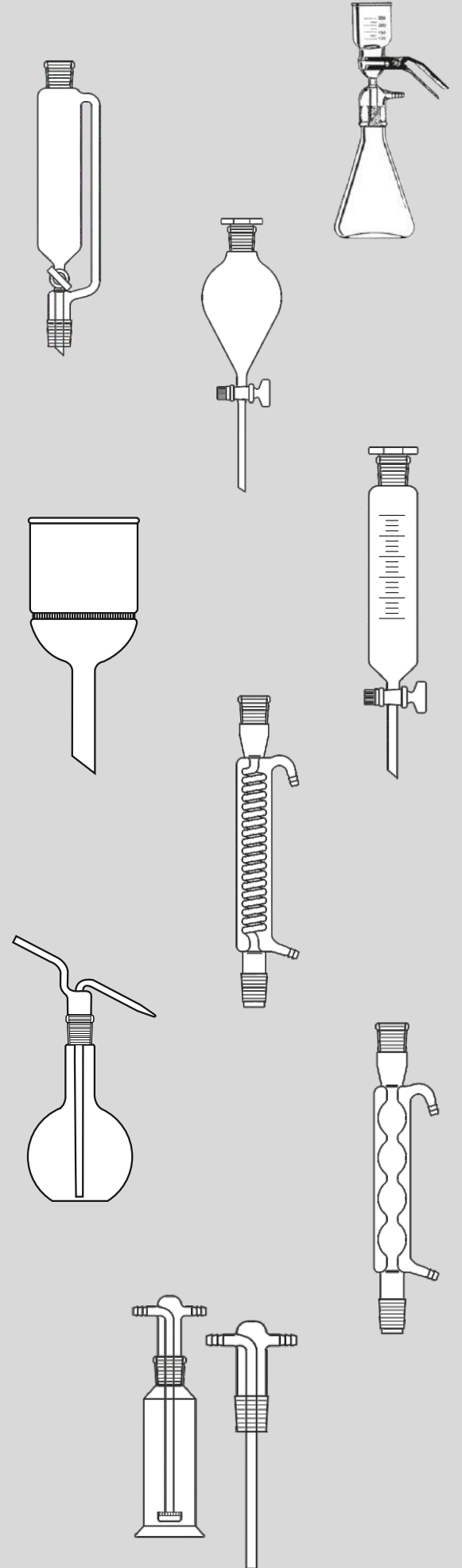

CAM MUSLUKLU Katalog No.	TEFLON MUSLUKLU Katalog No.	Hacim ml	Kapak NS	Musluk NS
01 110 - 00050	01 110 T50	50	19/26	14/23
01 110 - 00100	01 110 T100	100	19/26	14/23
01 110 - 00250	01 110 T250	250	29/32	14/23
01 110 - 00500	01 110 T500	500	29/32	14/23
01 110 - 01000	01 110 T1000	1000	29/32	19/26
01 110 - 02000	01 110 T2000	2000	29/32	19/26

**Ayırma Hunisi**  
Armudi



CAM MUSLUKLU Katalog No.	TEFLON MUSLUKLU Katalog No.	Hacim ml	Kapak NS	Musluk NS
01 111 - 00050	01 111 T50	50	19/26	14/23
01 111 - 00100	01 111 T100	100	19/26	14/23
01 111 - 00250	01 111 T250	250	29/32	14/23
01 111 - 00500	01 111 T500	500	29/32	14/23
01 111 - 01000	01 111 T1000	1000	29/32	19/26
01 111 - 02000	01 111 T2000	2000	29/32	19/26

**Ayırma Hunisi**  
Konik



CAM MUSLUKLU Katalog No.	TEFLON MUSLUKLU Katalog No.	Hacim ml	Kapak NS	Musluk NS
01 112 - 00050	01 112 T50	50	19/26	14/23
01 112 - 00100	01 112 T100	100	19/26	14/23
01 112 - 00250	01 112 T250	250	29/32	14/23
01 112 - 00500	01 112 T500	500	29/32	14/23
01 112 - 01000	01 112 T1000	1000	29/32	19/26

**Ayırma Hunisi**  
Silindirik



CAM MUSLUKLU Katalog No.	TEFLON MUSLUKLU Katalog No.	Hacim ml	Kapak NS	Musluk NS
01 113 - 00050	01 113 T50	50	19/26	14/23
01 113 - 00100	01 113 T100	100	19/26	14/23
01 113 - 00250	01 113 T250	250	29/32	14/23
01 113 - 00500	01 113 T500	500	29/32	14/23
01 113 - 01000	01 113 T1000	1000	29/32	19/26

**Ayırma Hunisi**  
Silindirik  
Dereceli



CAM MUSLUKLU Katalog No.	TEFLON MUSLUKLU Katalog No.	Hacim ml	Kapak NS	Musluk NS
01 115 - 00050	01 115 T50	50	19/26	14/23
01 115 - 00100	01 115 T100	100	19/26	14/23
01 115 - 00250	01 115 T250	250	29/32	14/23
01 115 - 00500	01 115 T500	500	29/32	14/23
01 115 - 01000	01 115 T1000	1000	29/32	19/26
01 115 - 02000	01 115 T2000	2000	29/32	19/26

**Damlatma Hunisi**  
Armudi





CAM MUSLUKLU Katalog No.	TEFLON MUSLUKLU Katalog No.	Hacim ml	Kapak NS	Musluk NS
01 117 - 00050	01 117 T50	50	19/26	14/23
01 117 - 00100	01 117 T100	100	19/26	14/23
01 117 - 00250	01 117 T250	250	29/32	14/23
01 117 - 00500	01 117 T500	500	29/32	14/23
01 117 - 01000	01 117 T1000	1000	29/32	19/26

**Damlatma Hunisi**  
Silindirik

CAM MUSLUKLU Katalog No.	TEFLON MUSLUKLU Katalog No.	Hacim ml	Kapak NS	Musluk NS
01 119 - 00050	01 119 T50	50	19/26	14/23
01 119 - 00100	01 119 T100	100	19/26	14/23
01 119 - 00250	01 119 T250	250	29/32	14/23
01 119 - 00500	01 119 T500	500	29/32	14/23
01 119 - 01000	01 119 T1000	1000	29/32	19/26

**Damlatma Hunisi**  
Silindirik  
Basınç Borulu

Katalog No.	Ceket Boyu/mm	Dişi Şilif/NS	Erkek Şilif/NS
01 101 - 00300	300	Yok	Yok
01 101 - 00400	400	Yok	Yok
01 101 - 00301	300	Yok	29/32
01 101 - 00401	400	Yok	29/32
01 101 - 00302	300	29/32	29/32
01 101 - 00402	400	29/32	29/32

**Düz Soğutucu (Liebeg)**

\* Şilif ve boyunları isteğe göre yapılır.

Katalog No.	Ceket Boyu/mm	Dişi Şilif/NS	Erkek Şilif/NS
01 102 - 00300	300	Yok	Yok
01 102 - 00400	400	Yok	Yok
01 102 - 00301	300	Yok	29/32
01 102 - 00401	400	Yok	29/32
01 102 - 00302	300	29/32	29/32
01 102 - 00402	400	29/32	29/32

**Bullu Soğutucu (Allihn)**

\* Şilif ve boyunları isteğe göre yapılır.

Katalog No.	Ceket Boyu/mm	Dişi Şilif/NS	Erkek Şilif/NS
01 103 - 00300	300	Yok	Yok
01 103 - 00400	400	Yok	Yok
01 103 - 00301	300	Yok	29/32
01 103 - 00401	400	Yok	29/32
01 103 - 00302	300	29/32	29/32
01 103 - 00402	400	29/32	29/32

**Sipiral Soğutucu**

\* Şilif ve boyunları isteğe göre yapılır.

Katalog No.	Ceket Boyu/mm	Dişi Şilif/NS	Erkek Şilif/NS
01 104 - 00302	300	29/32	29/32
01 104 - 00402	400	29/32	29/32

**Dimrot Soğutucu**

\* Şilif ve boyunları isteğe göre yapılır.

## Filtreli Kroze (Gooch)

Katalog No.	Hacim/ml	Prozite No.
01 170 - 00001	30	Por.1
01 170 - 00002	30	Por.2
01 170 - 00003	30	Por.3
01 170 - 00004	30	Por.4
01 171 - 00001	50	Por.1
01 171 - 00002	50	Por.2
01 171 - 00003	50	Por.3
01 171 - 00004	50	Por.4

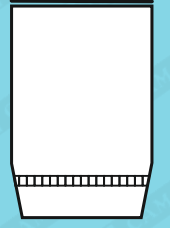

## Hunili Kroze

Katalog No.	Hacim/ml	Prozite No.
01 173 - 00001	30	Por.1
01 173 - 00002	30	Por.2
01 173 - 00003	30	Por.3
01 173 - 00004	30	Por.4
01 174 - 00001	50	Por.1
01 174 - 00002	50	Por.2
01 174 - 00003	50	Por.3
01 174 - 00004	50	Por.4
01 175 - 00001	75	Por.1
01 175 - 00002	75	Por.2
01 175 - 00003	75	Por.3
01 175 - 00004	75	Por.4
01 176 - 00001	125	Por.1
01 176 - 00002	125	Por.2
01 176 - 00003	125	Por.3
01 176 - 00004	125	Por.4



## Şilifli Kroze

Katalog No.	Hacim/ml	Şilif/NS	Prozite No.
01 177 - 00030	30	29/32	Por.1-2-3-4
01 177 - 00050	50	29/32	Por.1-2-3-4
01 177 - 00075	75	29/32	Por.1-2-3-4
01 177 - 00125	125	29/32	Por.1-2-3-4



## Vakumlu Kroze

Katalog No.	Hacim/ml	Şilif/NS	Prozite No.
01 178 - 00030	30	29/32	Por.1-2-3-4
01 178 - 00050	50	29/32	Por.1-2-3-4
01 178 - 00075	75	29/32	Por.1-2-3-4
01 178 - 00125	125	29/32	Por.1-2-3-4



## Selüloz Krozesi

Katalog No.	Hacim/ml	Çap/mm	Yükseklik/mm	Prozite No.
01 179 - 00002	30	24	60	Por.2

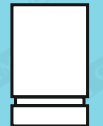

## Süzme Seti

Katalog No.	Erlen Hacmi/ml	Erlen Şilifi/NS	Hazne Hacmi/ml
01 900 - 00001	1000	40/38	300
01 900 - 00002	2000	40/38	300
01 900 - 00006	1000	40/38	300
01 900 - 00007	2000	40/38	300







Katalog No.	Hacim/ml	Ağız Çapı/mm
05 080 - 00100	100	24
05 080 - 00250	250	34
05 080 - 00500	500	34
05 080 - 01000	1000	45
05 080 - 02000	2000	60

## Nuçe Erlenisi



Katalog No.	Çap/mm
01 081 - 00027	27
01 081 - 00034	34
01 081 - 00041	41
01 081 - 00050	50

## Nuçe Hunisi



Katalog No.	Boy/mm
01 082 - 00001	275

## Su Trombu

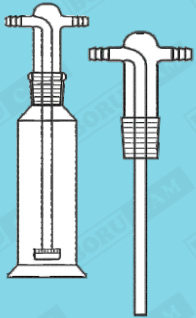

Katalog No.	Hacim/ml	Şilif/NS	
01 085 - 00100	100	29/32	Komple
01 085 - 00250	250	29/32	Komple
01 085 - 00500	500	29/32	Komple
01 086 - 00029	Başlık	29/32	Filtreli
01 086 - 00129	Başlık	29/32	Filtresiz

## Gaz Yıkama Şişesi

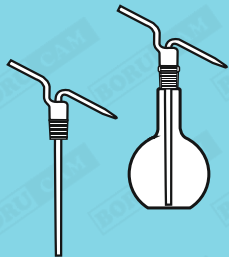

Katalog No.	Hacim/ml	Şilif/NS	
01 089 - 00100	250	29/32	Komple
01 089 - 00500	500	29/32	Komple
01 089 - 01000	1000	29/32	Komple
01 089 - 00001	Piset Başlığı 29/32		

## Piset



Katalog No.	Hacim/ml	
05 098 - 00250	250-300	Şeffaf
01 098 - 00251	250-300	Amber

## Bod Şişesi

**Vacum Trap**

Katalog No.	Şilif/NS	ÇapxBoy/mm	
01 190 - 00025	Yok	25x200	Tek Parça
01 190 - 00032	Yok	32x250	Tek Parça
01 190 - 00035	Yok	35x250	Tek Parça
01 190 - 00038	Yok	38x250	Tek Parça
01 190 - 00050	Yok	50x250	Tek Parça
01 191 - 00025	19/26	25x200	Şilifli
01 191 - 00032	29/32	32x250	Şilifli
01 191 - 00035	29/32	35x250	Şilifli
01 191 - 00038	29/32	38x250	Şilifli
01 191 - 00050	45/40	50x250	Şilifli

**Baget Termometre**

ALKOLLÜ Katalog No.	CİVALI Katalog No.	Skala °C	Çap mm	Boy mm
01 710 - 00050	01 711 - 00050	0-50°C	6-7	300
01 710 - 00100	01 711 - 00100	0-100°C	6-7	300
01 710 - 00150	01 711 - 00150	0-150°C	6-7	300
01 710 - 00200	01 711 - 00200	0-200°C	6-7	300
-	01 711 - 00250	0-250°C	6-7	300
-	01 711 - 00300	0-300°C	6-7	300
-	01 711 - 00360	0-360°C	6-7	300



# VOLÜMETRİK ÜRÜNLER

## VOLUMETRIC PRODUCTS

► **VOLÜMETRİK ÜRÜNLER**  
VOLUMETRIC PRODUCTS

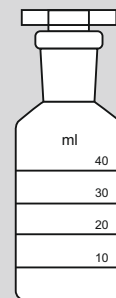
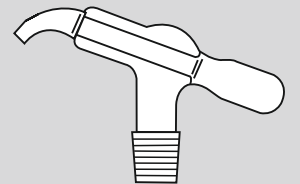
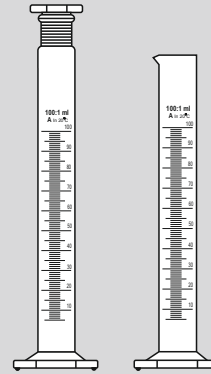
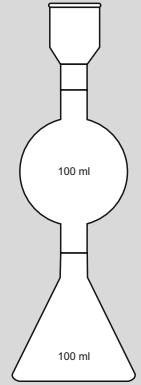
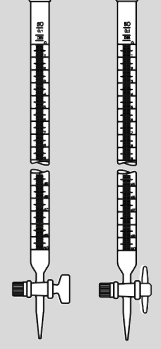

**Balon Joje**  
Pl. Kapaklı

Şeffaf Katalog No.	Amber Katalog No.	Hacim/ml	Prozite No.
05 200 - 00005	01 205 - 00005	5	10/19
05 200 - 00010	01 205 - 00010	10	10/19
05 200 - 00025	01 205 - 00025	25	10/19
05 200 - 00050	01 205 - 00050	50	12/21
05 200 - 00100	01 205 - 00100	100	14/23
05 200 - 00200	01 205 - 00200	200	14/23
05 200 - 00250	01 205 - 00250	250	14/23
05 200 - 00500	01 205 - 00500	500	19/26
05 200 - 01000	01 205 - 01000	1000	24/29
05 200 - 02000	01 205 - 02000	2000	29/32
05 200 - 05000	01 205 - 05000	5000	34/35

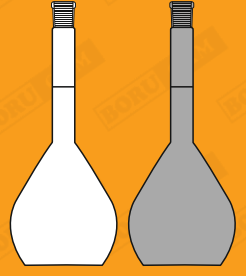

**Balon Joje**  
İki İşaretli  
(Şeker analizi için)

Katalog No.	Hacim/ml
01 200 05100	100-110



**Piknometre**  
Kalibrasyonlu

Katalog No.	Hacim ml	Başlık	Termometre
		NS	NS
01 211 - 00010	10	Başlıklı	12/21
01 211 - 00025	25	Başlıklı	12/21
01 211 - 00050	50	Başlıklı	12/21
01 211 - 00100	100	Başlıklı	14/23
01 212 - 00010	10	Termometreli	-
01 212 - 00025	25	Termometreli	-
01 212 - 00050	50	Termometreli	-
01 212 - 00100	100	Termometreli	-

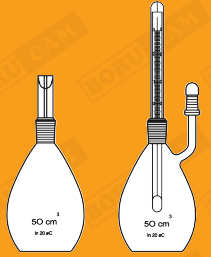

**Engler Viskozite Balonu**

Katalog No.	Hacim/ml
01 283 - 00100	100-100



**Saybolt Viskozite Balonu**

Katalog No.	Hacim/ml
01 284 - 00060	60



**La Chatalier Balonu**

Katalog No.	Hacim/ml	Derecelendirme	
		Balon Hacmi/ml	Boyun Hacmi/ml
01 285 - 00018	250	0-16	16-24/1,0



**Cassia Balonu**

Katalog No.	Hacim/ml	Derecelendirme	
		Balon Hacmi/ml	Boyun Hacmi/ml
03 905 - 00001	250	0-5/0,1	10-30/1,0







Katalog No.	Hacim/ml
05 230 - 00001	1
05 230 - 00002	2
05 230 - 00005	5
05 230 - 00010	10
05 230 - 00025	25
05 230 - 00050	50
05 230 - 00100	100

**Bullu Pipet**

Katalog No.	Hacim/ml
05 231 - 00001	1
05 231 - 00002	2
05 231 - 00005	5
05 231 - 00010	10
05 231 - 00020	20
05 231 - 00025	25
05 231 - 00050	50

**Dereceli Pipet**

Katalog No.	Hacim/ml	Şilif/NS
01 234 - 00001	1	29/32
01 234 - 00002	2	29/32
01 234 - 00005	5	29/32
01 234 - 00010	10	29/32
01 234 - 00015	15	29/32
01 234 - 00020	20	29/32
01 234 - 00025	25	29/32
01 234 - 00050	50	29/32
01 234 - 00100	100	29/32

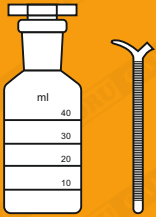
**Otomatik Pipet Başlığı**

Katalog No.	Hacim/ml	
01 280 - 00001	Musluksuz	-
01 280 - 00002	Musluklu	-
01 281 - 00001	Şişesi	40

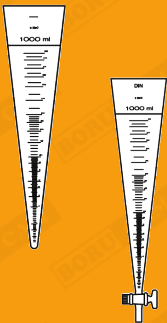
**Hidrometri Büreti**

Katalog No.	Hacim/ml	
01 282 - 01000	Musluksuz	1000
01 282 - 02000	Teflon Musluklu	1000

**İmhof Hunisi**

**Büret  
B klass**

Cam Musluklu Katalog No.	Teflon Musluklu Katalog No.	Hacim/ml	Taksimat/ml
01 239 - 00010	01 239 T10	10	1/20
01 239 - 00025	01 239 T25	25	1/20
01 239 - 00050	01 239 T50	50	1/10
01 239 - 00100	01 239 T100	100	1/5

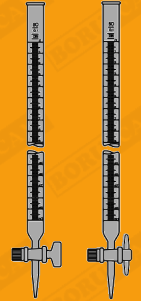
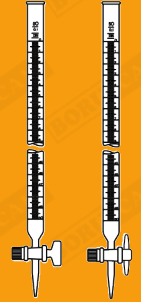
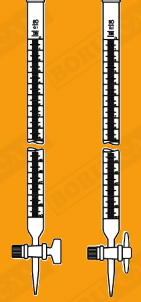

**Büret  
A klass**

Cam Musluklu Katalog No.	Teflon Musluklu Katalog No.	Hacim/ml	Taksimat/ml
01 240 - 00010	01 240 T10	10	1/20
01 240 - 00025	01 240 T25	25	1/20
01 240 - 00050	01 240 T50	50	1/10
01 240 - 00100	01 240 T100	100	1/5

**Büret  
Amber renk  
A klass**

Cam Musluklu Katalog No.	Teflon Musluklu Katalog No.	Hacim/ml	Taksimat/ml
01 241 - 00010	01 241 T10	10	1/20
01 241 - 00025	01 241 T25	25	1/20
01 241 - 00050	01 241 T50	50	1/10

**Otomatik Büret  
A klass  
Tek Musluklu**

Cam Musluklu Katalog No.	Teflon Musluklu Katalog No.	Hacim/ml	Taksimat/ml
01 251 - 00010	01 251 T10	10	1/20
01 251 - 00025	01 251 T25	25	1/20
01 251 - 00050	01 251 T50	50	1/10
01 251 - 00100	01 251 T100	100	1/5



**Otomatik Büret  
A klass  
iki Musluklu**

Cam Musluklu Katalog No.	Teflon Musluklu Katalog No.	Hacim/ml	Taksimat/ml
01 252 - 00010	01 252 T10	10	1/20
01 252 - 00025	01 252 T25	25	1/20
01 252 - 00050	01 252 T50	50	1/10
01 252 - 00100	01 252 T100	100	1/5



**Otomatik Büret  
Amber renk  
A klass  
Tek Musluklu**

Cam Musluklu Katalog No.	Teflon Musluklu Katalog No.	Hacim/ml	Taksimat/ml
01 261 - 00010	01 261 T10	10	1/20
01 261 - 00025	01 261 T25	25	1/20
01 261 - 00050	01 261 T50	50	1/10



**Otomatik Büret  
Amber renk  
A klass  
iki Musluklu**

Cam Musluklu Katalog No.	Teflon Musluklu Katalog No.	Hacim/ml	Taksimat/ml
01 262 - 00010	01 262 T10	10	1/20
01 262 - 00025	01 262 T25	25	1/20
01 262 - 00050	01 262 T50	50	1/10





Katalog No.		Hacim/ml
05 265 - 00001	Şeffaf	2000
05 266 - 00001	Amber	2000
01 265 - 00010	Lastik Puar	-

**Otomatik Büret Şişesi**

Katalog No.	Hacim/ml	
01 258 - 00025	25	Paralel yollu musluklu
01 258 - 00050	50	Paralel yollu musluklu
01 258 - 00100	100	Paralel yollu musluklu

**Yarı Otomatik Büret**

Katalog No.	Hacim/ml		
01 267 - 00010	10	29/32	ŞEFFAF
01 268 - 00010	10	29/32	AMBER

**Kazan Otomatik Büreti**  
İçten Borulu

Katalog No.	Hacim/ml	
01 270 - 00025	25 SH	29/32
01 270 - 00040	40 SH	29/32

**SH Otomatik Büreti**

Kapaksız Katalog No.	Kapaklı Katalog No.	Hacim/ml	Şilif/NS
05 296 - 00005	01 297 - 00005	5	12/21
05 296 - 00010	01 297 - 00010	10	19/26
05 296 - 00025	01 297 - 00025	25	19/26
05 296 - 00050	01 297 - 00050	250	24/29
05 296 - 00100	01 297 - 00100	100	29/32
05 296 - 00250	01 297 - 00250	250	29/32
05 296 - 00500	01 297 - 00500	500	29/32
05 296 - 01000	01 297 - 01000	1000	-
05 296 - 02000	01 297 - 02000	2000	-

**Mezür**Uzun Form  
Kapaklı  
Kapaksız

Katalog No.	Musluk
01 292 - 00010	10
01 292 - 00025	25
01 292 - 00050	50
01 292 - 00100	100
01 292 - 00250	250
01 292 - 00500	500

**Mezür**

KısaForm

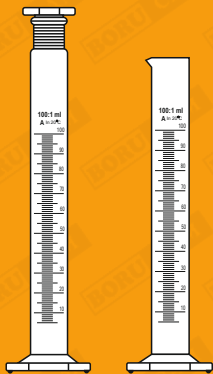
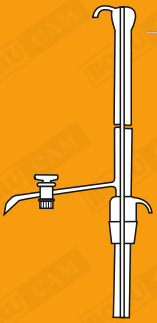

# TÜPLER TUBES

► TÜPLER  
TUBES

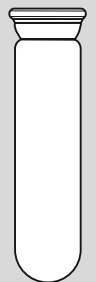
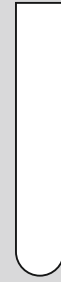
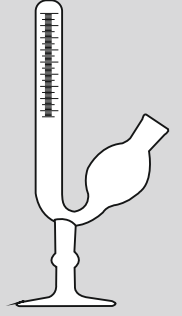
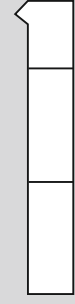



Katalog No.	Çap/mm	Boy/mm
05 400 - 10100	10	100
05 400 - 13100	13	100
05 400 - 16100	16	100
05 400 - 16160	16	160
05 400 - 18180	18	180
05 400 - 20200	20	200
05 400 - 25150	25	150
05 400 - 25200	25	200

**Deney Tüpü**

Katalog No.	Çap/mm	Boy/mm
01 404 - 00630	6	30
01 404 - 00640	6	40
01 404 - 00750	7	50
01 404 - 00830	8	30
01 404 - 00840	8	40
01 404 - 00950	9	50
01 404 - 01035	10	35
01 404 - 01040	10	40

**Durham Tüpü**

Katalog No.	Hacim/ml	Çap/mm	Boy/mm
01 405 - 00006	6	13	100
01 405 - 00012	12	17	98
01 405 - 00025	25	25	93
01 405 - 00050	50	34	98
01 405 - 00080	80	40	115
01 405 - 00100	100	45	98

**Santrifüj Tüpü**  
Kalın Cıdarlı

Katalog No.	Hacim/ml	Çap/mm	Boy/mm	Şilif/NS
01 413 - 00006	6	17	121	14/23
01 413 - 00012	12	25	119	19/26
01 413 - 00025	25	34	130	29/32
01 413 - 00050	50	40	147	29/32
01 413 - 00080	80	45	130	29/32

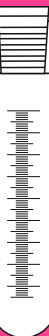
**Şilifli Tüp**  
Kalın Cıdarlı

Katalog No.	Hacim/ml	Çap/mm	Boy/mm	Şilif/NS
01 414 - 00006	6	17	121	14/23
01 414 - 00012	12	25	119	19/26
01 414 - 00025	25	34	130	29/32
01 414 - 00050	50	40	147	29/32
01 414 - 00080	80	45	130	29/32

**Şilifli Tüp**  
Kalın Cıdarlı  
Dereceli

## TÜPLER

### Petrol Test Tüpü

Dibi Konik  
Dibi Armudi

Katalog No.	Hacim/ml	
01 422 - 00050	50	Dibi konik dereceli
01 422 - 00100	100	Dibi konik dereceli
01 424 - 00100	50	Armudi dereceli

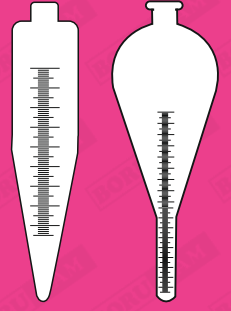

### Fermentasyon Tüpü

Katalog No.	Hacim/ml
01 426 - 00005	5
01 426 - 00010	10



### Nessler Tüpü

Katalog No.	Hacim/ml	Çap/mm	Boy/mm
01 433 - 00050	50	26	175
01 433 - 00100	100	32	200



### Nessler Tüpü Plastik Kapaklı

Katalog No.	Hacim/ml	Çap/mm	Boy/mm
01 434 - 00050	50	26	175
01 434 - 00100	100	32	200



### Yakma Tüpü

Katalog No.	Ağız	ÇapxBoy/mm
03 001 - 00100	Faturalı	42x300
03 001 - 00135	KS 35	42x300
03 001 - 00140	KS 40	42x300
03 001 - 00102	Özel	48x260
03 001 - 00104	Özel	70x300



### Erime Noktası Tayin Tüpü

Katalog No.	Hacim/ml
01 440 - 00001	-





# KOLONLAR COLUMNS

►► KOLONLAR  
COLUMNS

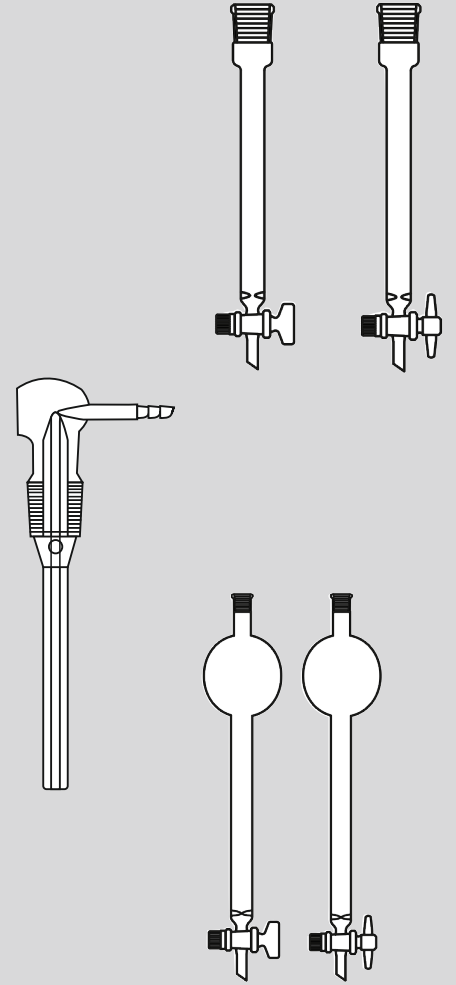

**Kromatografi Kolonu**  
Şilifsiz

Cam Musluklu Katalog No.	Teflon Musluklu Katalog No.	Çap mm	Boy mm
01 245 - 00152	01 245 T152	15	200
01 245 - 00202	01 245 T202	20	200
01 245 - 00204	01 245 T204	20	400
01 245 - 00302	01 245 T302	30	200
01 245 - 00304	01 245 T304	30	400
01 245 - 00404	01 245 T404	40	400

**Kromatografi Kolonu**  
Şilifli

Cam Musluklu Katalog No.	Teflon Musluklu Katalog No.	Çap mm	Boy mm	Şilif NS
01 246 - 00152	01 246 T152	15	200	200
01 246 - 00202	01 246 T202	20	200	200
01 246 - 00204	01 246 T204	20	400	400
01 246 - 00302	01 246 T302	30	200	200
01 246 - 00304	01 246 T304	30	400	400
01 246 - 00404	01 246 T404	40	400	400

**Kromatografi Kolonu**  
Filtreli

Cam Musluklu Katalog No.	Teflon Musluklu Katalog No.	Çap mm	Boy mm	Şilif NS	Filtre
01 247 - 00152	01 247 T152	15	200	200	200
01 247 - 00202	01 247 T202	20	200	200	200
01 247 - 00204	01 247 T204	20	400	400	400
01 247 - 00302	01 247 T302	30	200	200	200
01 247 - 00304	01 247 T304	30	400	400	400
01 247 - 00404	01 247 T404	40	400	400	400

**Kromatografi Kolonu**  
Balonlu

Cam Musluklu Katalog No.	Teflon Musluklu Katalog No.	Çap mm	Boy mm	Şilif NS	Balon Hacmi/ml
01 248 - 00152	01 248 T152	15	200	200	250
01 248 - 00202	01 248 T202	20	200	200	250
01 248 - 00204	01 248 T204	20	400	400	250
01 248 - 00302	01 248 T302	30	200	200	500
01 248 - 00304	01 248 T304	30	400	400	500
01 248 - 00404	01 248 T404	40	400	400	500

**Kromatografi Kolonu**  
Balonlu  
Filtreli

Cam Musluklu Katalog No.	Teflon Musluklu Katalog No.	Çap mm	Boy mm	Şilif NS	Balon Hacmi/ml
01 249 - 00152	01 249 T152	15	200	200	250
01 249 - 00202	01 249 T202	20	200	200	250
01 249 - 00204	01 249 T204	20	400	400	250
01 249 - 00302	01 249 T302	30	200	200	500
01 249 - 00304	01 249 T304	30	400	400	500
01 249 - 00404	01 249 T404	40	400	400	500

**Puarlı Sprey**

Katalog No.	Hacim/ml	Şilif/NS
01 091 - 00100	Püskürtücü	-
05 005 - 00100	Şilifli Erlen	100
05 503 - 00019	Plastik Şilif Kıskacı	-

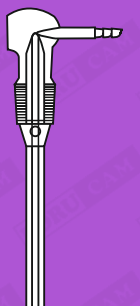
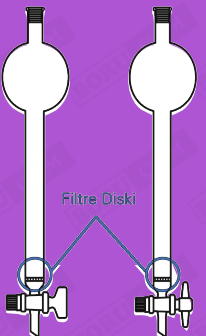
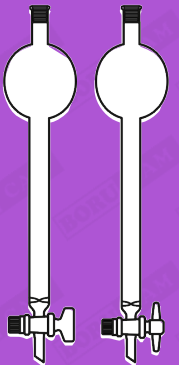
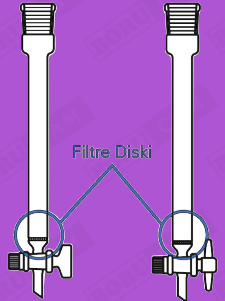
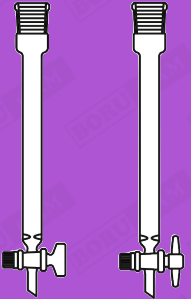
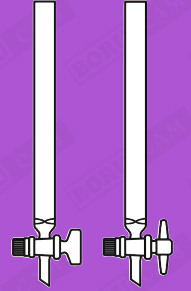

# BAĞLANTI PARÇALARI FITTINGS

▶▶ BAĞLANTI PARÇALARI  
FITTINGS

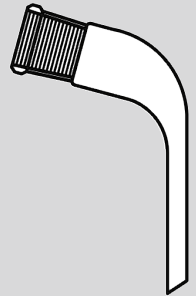
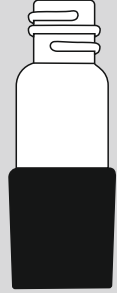
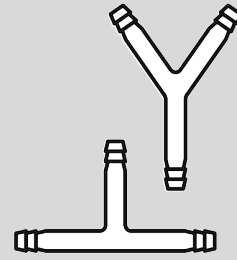

## Konik Kapak

Cam

Plastik

Cam Kapak Katalog No.	Plastik Katalog No.	Kapak NS
01 521 - 00010	05 520 - 00010	10/19
01 521 - 00012	05 520 - 00012	12/21
01 521 - 00014	05 520 - 00014	14/23
01 521 - 00019	05 520 - 00019	19/26
01 521 - 00024	05 520 - 00024	24/29
01 521 - 00029	05 520 - 00029	29/32
01 521 - 00034	05 520 - 00034	34/35
01 521 - 00045	05 520 - 00045	45/40

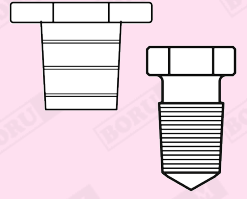

## Plastik Vidalı Rakor

Ortası Delik

Rakor Katalog No.	Conta Katalog No.	Kapak GL	Kapak GL
01 527 - 00010	01 528 - 00010	14	14
01 527 - 00012	01 528 - 00012	18	18
01 527 - 00014	01 528 - 00014	25	25
01 527 - 00019	01 528 - 00019	32	32
01 527 - 00024	01 528 - 00024	45	45

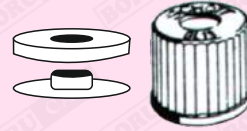

## Konik Şilif Kısıkaçı

Plastik

Katalog No.	Şilif/NS
05 503 - 00014	14/23
05 503 - 00019	19/26
05 503 - 00024	54/29
05 503 - 00029	29/32
05 503 - 00034	34/35
05 503 - 00040	40/740
05 503 - 00045	45/40



## Küresel Şilif Kısıkaçı

Metal

Cam Kapak Katalog No.	Şilif NS
01 507 - 00014	13/5
01 507 - 00019	19/9
01 507 - 00024	29/15
01 507 - 00029	25/20
01 507 - 00034	40/25

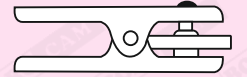

## Hortum Bağlantısı

T Tip

Y Tip

T Tip Katalog No.	Y Tip Katalog No.	Çap mm	Boy mm
01 535 - 00006	01 536 - 00006	6	T Tip 120
01 535 - 00008	01 536 - 00008	8	T Tip 120
01 535 - 00010	01 536 - 00010	10	T Tip 120

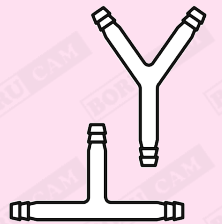

## Vidalı Adaptör

Katalog No.	Vida GL	Erkek Şilif NS
01 622 - 01414	14	14/23
01 622 - 01419	14	19/26
01 622 - 01424	14	24/29
01 622 - 01429	14	29/32
01 622 - 01814	18	14/23
01 622 - 01819	18	19/26
01 622 - 01824	18	24/29
01 622 - 01829	18	29/32
01 622 - 02524	25	24/29
01 622 - 02529	25	29/32

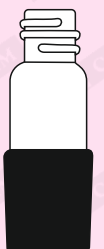

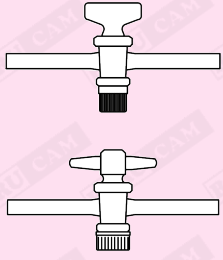

Cam Musluk Katalog No.	Teflon Musluk Katalog No.	Çap mm	Boy mm
01 551 - 00012	01 551 T12	12,5	2
01 551 - 00014	01 551 T14	14,5	3
01 551 - 00019	01 551 T19	19	4
01 551 - 00024	01 551 T24	24	6

**Musluk İki Yollu**

Cam  
Teflon

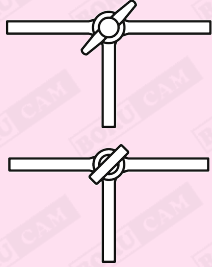

Cam Kapak Katalog No.	Plastik Katalog No.	Musluk NS	Delik Çapı mm
01 553 - 00014	01 553 T14	14,5	3
01 553 - 00019	01 553 T19	19	4
01 553 - 00024	01 553 T24	24	6

**Musluk Üç Yollu**

Cam Musluk  
Teflon Musluk

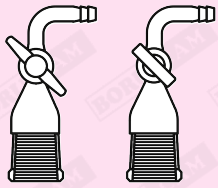

Cam Musluk Katalog No.	Teflon Musluk Katalog No.	Musluk NS	Şilif NS
01 564 - 00014	01 564 T14	14,5	14/23
01 564 - 00019	01 564 T19	14,5	19/26
01 564 - 00024	01 564 T24	14,5	24/29
01 564 - 00029	01 564 T29	14,5	29/32

**Şilifli Musluk**

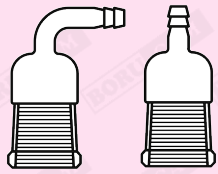

Cam Kapak Katalog No.	Erkek Şilif NS	Hortum Ucu mm
01 615 - 00014	14/23	8
01 615 - 00019	19/26	8
01 615 - 00024	24/29	8
01 615 - 00029	29/32	8

**Distilasyon Çıkış Borusu**

Şilifli



Cam Kapak Katalog No.	Dişi Şilif NS
01 618 - 00014	14/23
01 618 - 00019	19/26
01 618 - 00024	24/29
01 618 - 00029	29/32

**Distilasyon Çıkış Borusu  
(Alonj)**



Katalog No.	Dişi Şilif NS	Erkek Şilif NS
01 620 - 01429	14/23	19/26
01 620 - 01424	14/23	24/29
01 620 - 01429	14/23	29/32
01 620 - 01924	19/26	24/29
01 620 - 01929	19/26	29/32
01 620 - 02429	24/29	29/32
01 620 - 02945	29/32	45/40

**Küçültme Adaptörü**



Katalog No.	Dişi Şilif NS	Erkek Şilif NS
01 621 - 01914	19/26	14/23
01 621 - 02414	24/29	14/23
01 621 - 02419	24/29	19/26
01 621 - 02914	29/32	14/23
01 621 - 02919	29/32	19/26
01 621 - 02924	29/32	24/29
01 621 - 04529	45/40	29/32

**Küçültme Adaptörü**

**Gaz Giriş Borusu**Musluksuz  
Musluklu

Musluksuz Katalog No.	Musluklu Katalog No.	Erkek Şilif NS
01 601 - 00014	01 603 - 00014	14/23
01 601 - 00019	01 603 - 00019	19/26
01 601 - 00024	01 603 - 00024	24/29
01 601 - 00029	01 603 - 00029	29/32

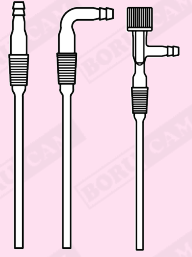
**İki Boyunlu Adaptör**

Katalog No.	Erkek Şilif NS	Dişi Şilif NS
01 632 - 01919	14/23	2x19/26
01 632 - 02929	29/32	2x29/32

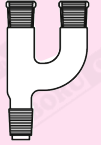
**Üç Boyunlu Adaptör**

Katalog No.	Erkek Şilif NS	Dişi Şilif NS
01 633 - 00001	29/32	3x19/26
01 633 - 00002	29/32	3x29/32
01 633 - 00003	45/40	3x29/32

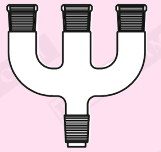
**Dirsek**

75 °C Açılı

Katalog No.	Erkek Şilif NS	Dişi Şilif NS
01 640 - 01414	14/23	14/23
01 640 - 01919	19/26	19/26
01 640 - 02929	29/32	29/32

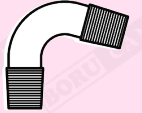
**Dirsek**

90 °C Açılı

Katalog No.	Erkek Şilif NS	Dişi Şilif NS
01 641 - 01414	14/23	14/23
01 641 - 01919	19/26	19/26
01 641 - 02929	29/32	29/32

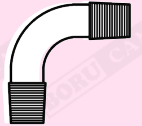
**Vakumlu Adaptör**

Düz

Katalog No.	Erkek Şilif NS	Erkek Şilif NS
01 645 - 01414	14/23	14/23
01 645 - 01919	19/26	19/26
01 645 - 02929	29/32	29/32

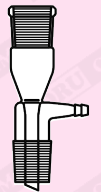
**Vakumlu Adaptör**

105 °C Açılı

Katalog No.	Erkek Şilif NS	Erkek Şilif NS
01 646 - 01414	14/23	14/23
01 646 - 01919	19/26	19/26
01 646 - 02929	29/32	29/32

**Distilasyon Başlığı**

Cam Musluk Katalog No.	Dişi Şilif NS	Erkek Şilif NS	Erkek Şilif NS
01 650 - 02919	14/23	29/32	19/26
01 650 - 02929	14/23	29/32	29/32
01 650 - 04529	14/23	45/40	29/32

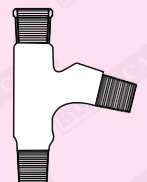





Katalog No.	Erkek Şilif/NS	Erkek Şilif/NS
01 655 - 01414	14/23	14/23
01 655 - 01919	19/26	19/26
01 655 - 02929	29/32	29/32

**Sıçrama Başlıklı Adaptör**  
Düz



Katalog No.	Erkek Şilif/NS	Erkek Şilif/NS
01 656 - 01414	14/23	14/23
01 656 - 01919	19/26	19/26
01 656 - 02929	29/32	29/32

**Sıçrama Başlıklı Adaptör**  
75° Açılı



Katalog No.	Erkek Şilif/NS	Erkek Şilif/NS
01 660 - 01414	14/23	14/23
01 660 - 01919	19/26	19/26
01 660 - 02929	29/32	29/32

**Distilasyon Köprüsü**

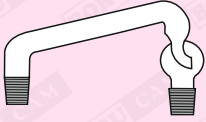

Katalog No.	Erkek Şilif/NS	Erkek Şilif/NS
01 661 - 01414	14/23	14/23
01 661 - 01919	19/26	19/26
01 661 - 02929	29/32	29/32

**Distilasyon Köprüsü**  
Sıçrama Başlıklı

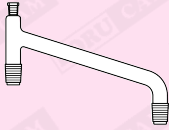

Katalog No.	Term. Şilifi NS	Erkek Şilif NS	Erkek Şilif NS
01 662 - 01414	14/23	14/23	14/23
01 662 - 01919	14/23	19/26	19/26
01 662 - 02929	14/23	29/32	29/32

**Distilasyon Köprüsü**  
Termometre Şilifli

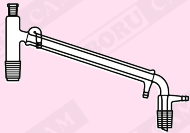

Katalog No.	Term. Şilifi NS	Erkek Şilif NS	Soğutucu NS
01 670 - 01414	14/23	14/23	14/23
01 670 - 01919	14/23	19/26	19/26
01 670 - 02929	14/23	29/32	29/32

**Distilasyon Köprüsü**  
Termometre Şilifli  
Soğutuculu  
Vakum Çıkışlı

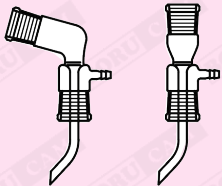

Düz Başlık Katalog No.	Açılı Başlık Katalog No.	Üst NS	Alt NS
01 680 - 01926	01 681 - 01926	19/26	19/26
01 680 - 02932	01 681 - 02932	29/32	29/32

**Bredt Distilasyon Toplama Başlığı**

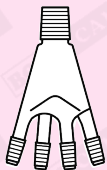

Katalog No.	Hacim ml	Üst Erkek Şilif NS	Alt Erkek Şilif NS
01 681 - 01926	50	19/26	14/23
01 681 - 02429	100	24/29	14/23
01 681 - 02932	100	29/32	14/23

**Bredt Distribütör**

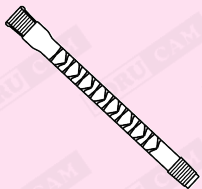

Katalog No.	Üst/NS	Alt/NS	Boy/mm
01 690 - 00200	14/23	14/23	200
01 690 - 00300	29/32	19/26	300
01 690 - 00400	14/23	29/32	400
01 690 - 00500	29/32	29/32	500

**Vigreux Distilasyon Kolonu**

# ALETLER TOOLS

▶▶ ALETLER  
TOOLS

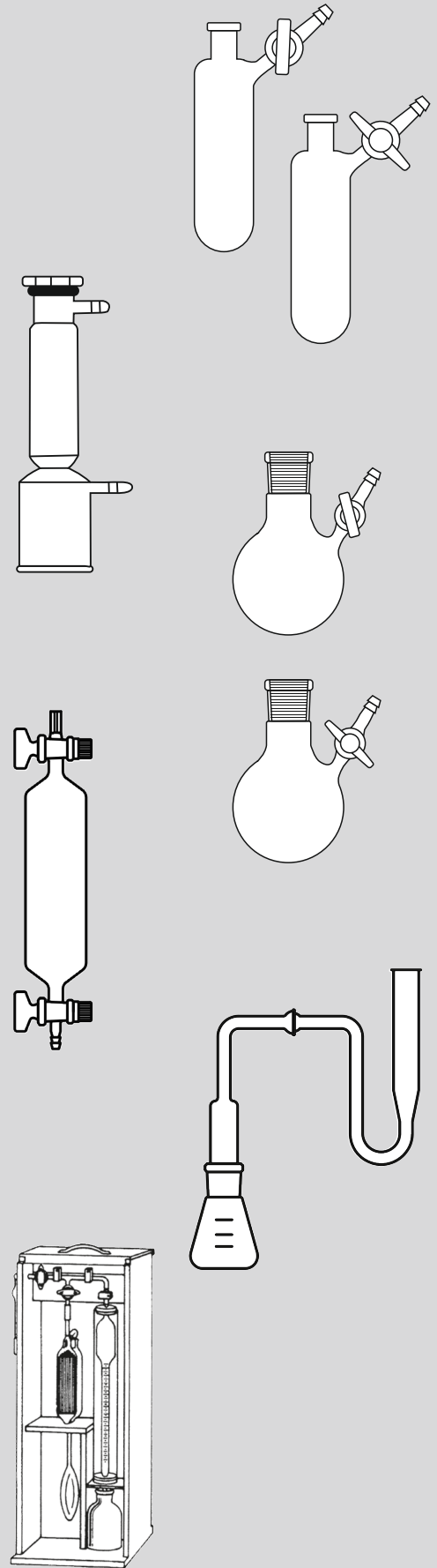

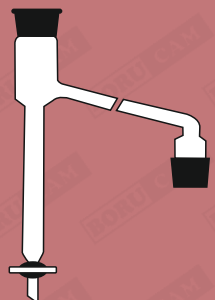
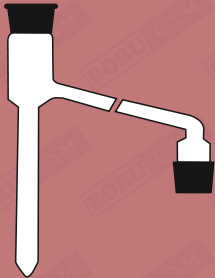
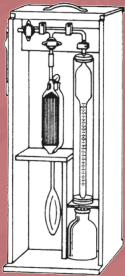
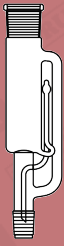

Katalog No.	Hacim ml	Erkek Şilif NS	Dişi Şilif NS
01 303 - 00030	30	29/32	29/32
01 303 - 00070	70	29/32	34/35
01 303 - 00100	100	29/32	45/40
01 303 - 00150	150	29/32	45/40
01 303 - 00250	250	29/32	45/40
01 303 - 00500	500	29/32	-
01 303 - 01000	1000	29/32	-

**Ekstraktör**

Katalog No.	Ceket Boyu/mm	Şilif/NS
01 305 - 00150	160	29/32
01 305 - 00200	200	34/35
01 305 - 00250	250	45/40
01 305 - 00300	300	45/40
01 305 - 00400	400	45/40

**Soxleth Soğutucusu**

Bullu

Katalog No.	Ceket Boyu/mm	Şilif/NS
01 306 - 00300	300	45/40
01 306 - 00400	400	45/40

**Soxleth Soğutucusu**

Dimrot

Katalog No.	Hacim ml	Boyun NS	Musluk
01 310 - 00100			Komple, Set
01 310 - 10100			Parçaları
01 310 - 10101			ORSAT Büreti
01 310 - 10101			ORSAT Abbsobsiyon Kolonu
01 310 - 10102			ORSAT Musluk Köprüsü
01 310 - 10103			ORSAT Seviye Şişesi

**Orsat Gaz Analiz Cihazı**

Katalog No.	Hacim/ml	Şilif/NS
01 322 - 00010	10	29/32
01 322 - 00015	15	29/32
01 322 - 00025	25	29/32

**Ksilol Cihazı Ölçü Tüpü**

Musluksuz

Katalog No.	Hacim/ml	Şilif/NS
01 323 - 00010	10	29/32
01 323 - 00015	15	29/32
01 323 - 00025	25	29/32

**Ksilol Cihazı Ölçü Tüpü**

Musluklu

**ALETLER****Sudan Hafif Yağ Tayin Cihazı  
Ölçü Tüpü**

Katalog No.	Hacim/ml	Şilif/NS
01 324 - 00005	5	29/32
01 324 - 00013	13	29/32

**Sudan Ağır Yağ Tayin Cihazı  
Ölçü Tüpü**

Katalog No.	Hacim/ml	Şilif/NS
01 325 - 00005	5	29/32
01 325 - 00013	13	29/32

**Arsenik Tayin Cihazı**

Katalog No.	Erlen/ml	Şilif/NS	Şilif/NS
01 315 - 00100	100	29/32	Şilifli
01 315 - 00200	100	29/32	Flanşlı
01 315 - 00300	100	29/32	KS Şilifli

**Kurutma Kulesi**

Katalog No.	Çap/mm	Boy/mm
01 365 - 40240	40	240
01 365 - 45315	45	315

**Gaz Numune Alma Kabı**

Cam Musluklu

Teflon Musluklu

Cam Musluklu Katalog No.	Tek Musluklu Katalog No.	Hacim ml	Çap mm	Boy mm
01 088 - 00100	88 T100	100	-	-
01 088 - 00250	88 T250	250	-	-
01 088 - 00500	88 T500	500	-	-
01 088 - 01000	88 T1000	1000	-	-

**Gaz Numune Alma Kabı**

GL 14 Borulu

Cam Musluklu

Teflon Musluklu

Cam Musluklu Katalog No.	Tek Musluklu Katalog No.	Hacim ml	Boru GL	Çap mm	Boy mm
01 088 - 00001	01 088 T1	100	100	-	-
01 088 - 00002	01 088 T2	250	250	-	-
01 088 - 00003	01 088 T3	500	500	-	-
01 088 - 00004	01 088 T4	1000	1000	-	-

**Azot (Schlenk) Balonu**

Cam Musluklu

Teflon Musluklu

Cam Musluklu Katalog No.	Tek Musluklu Katalog No.	Hacim ml	Boyun NS
03 391 - 00050	03 391 T50	50	14/23
03 391 - 00100	03 391 T100	100	14/23
03 391 - 00250	03 391 T250	250	14/23
03 392 - 00050	03 392 T50	50	29/32
03 392 - 00100	03 392 T100	100	29/32
03 392 - 00250	03 392 T250	250	29/32
03 392 - 00500	03 392 T500	500	29/32
03 392 - 01000	03 392 T1000	1000	29/32

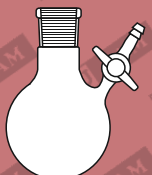
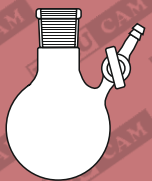
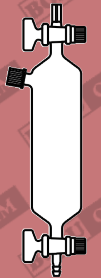
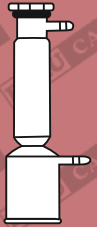
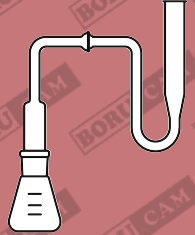
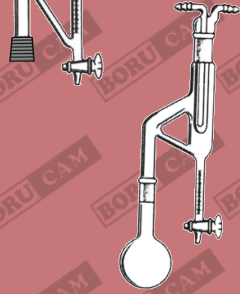
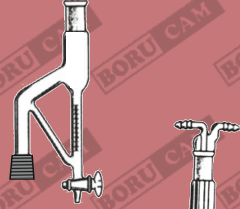

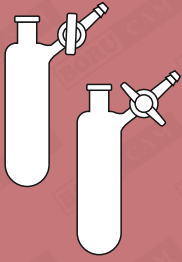

Cam Musluklu Katalog No.	Teflon Musluklu Katalog No.	Hacim ml	Boyun NS
03 392 - 00025	03 392 T25	25	14/23
03 392 - 00050	03 392 T50	50	14/23
03 392 - 00100	03 392 T100	100	14/23
03 392 - 00101	03 392 T101	100	29/32

**Azot (Schlenk) Tüpü**

Cam Musluklu  
Teflon Musluklu

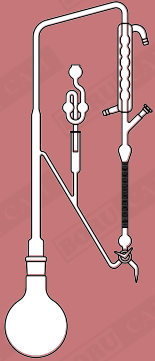

Katalog No.	Ölçü Tüpü/ml	Şilif/NS	Şilif/NS
03 500 - 00230	1	1000	29/32
03 500 - 00231	2	1000	29/32
03 500 - 00250	5	1000	29/32
03 500 - 01000	10	1000	29/32

**Clevenger Cihazı**

Uçucu Yağ Tayin Cihazı

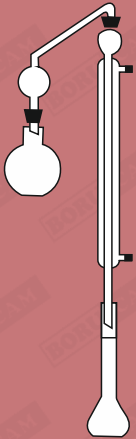

Katalog No.	Musluk
00 367 - 00001	Komple Set
Parçaları	
00 906 - 00010	Köprü 2x29/32
00 024 - 00500	Balon 500 ml Dibi Yuvarlak 29/32
00 101 - 00300	Düz Soğutucu, Şilifsiz
00 200 - S100	Balon Joje 1000-110 ml

**Polenske (Lefman) Cihazı**

Katalog No.	Musluk
01 370 - 00001	Komple Set
Parçaları	
00 370 - 00002	Tüp 2 ml
00 370 - 00004	Tüp 4 ml
00 370 - 00010	Tüp 10 ml
00 370 - 00015	Tüp 15 ml
00 370 - 00020	Balon 500 ml üst 29/32 alt 19/26
00 370 - 00025	Kolon Üst 29/32 Alt 29/32

**Kuderna Danish Cihazı**

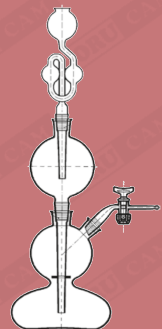

Katalog No.	Hacim/ml	Boyun/NS
01 438 - 00500	500	34/35
01 438 - 01000	1000	34/35

**Kipp Cihazı**

## CAM BORULAR GLASS TUBES

▶▶ CAM BORULAR  
GLASS TUBES





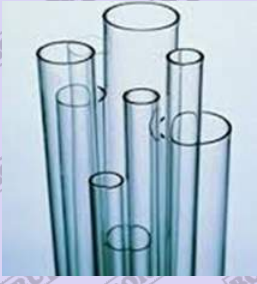

Katalog No.	Çap/mm	Et Kalınlığı/mm	Boy/mm
90 xxx xxxxx	6-9	1,0-1,5	1500
90 xxx xxxxx	10-14	1,0-2,2	1500
90 xxx xxxxx	15-24	1,2-2,5	1500
90 xxx xxxxx	26-38	1,4-2,8	1500
90 xxx xxxxx	40-48	1,6-3,2	1500
90 xxx xxxxx	50-58	1,8-5,0	1500
90 xxx xxxxx	60-75	2,2-5,0	1500
90 xxx xxxxx	80-100	2,5-5,0	1500
90 xxx xxxxx	105-150	3,0-5,0	1500

\* İstenilen uzunlukta kesilir.

Katalog No.	Çap/mm	Boy/mm
91 xxx xxxxx	4-5-6-7-8-9-10	1200

\* İstenilen uzunlukta kesilir.

Katalog No.	Çap/mm	Et Kalınlığı/mm	Boy/mm
92 030 - 01500	30	2,0	1500
92 040 - 01500	40	2,0	1500
92 050 - 01500	50	2,5	1500
92 060 - 01500	60	2,5	1500
92 070 - 01500	70	2,8	1500
92 080 - 01500	80	3,2	1500
92 090 - 01500	90	3,2	1500
92 100 - 01500	100	3,5	1500

\* İstenilen uzunlukta kesilir.

Katalog No.	Çap/mm	Et Kalınlığı/mm	Boy/mm
93 001 00020	20	2,5	1500

Katalog No.	Çap/mm	Et Kalınlığı/mm	Boy/mm
98 008 - 01350	8	1,2	1500
98 010 - 01350	10	1,2	1500
98 018 - 01350	18	1,2	1350
98 021 - 01700	21	1,0	1700
98 022 - 01600	22	1,5	1600
98 025 - 01650	25	1,2	1650
98 030 - 01500	30	2,0	1500
98 040 - 01500	40	2,0	1500
98 050 - 01500	50	2,0	1500

\* İstenilen uzunlukta kesilir.

Katalog No.	Çap/mm	Boy/mm
99 013 - 2000	13	2000
99 015 - 2000	15	2000
99 017 - 2000	17	2000
99 018 - 2000	18	2000
99 020 - 2000	20	2000
99 022 - 2000	22	2000

\* Eklenecek boyları istenilen uzunlukta yapılır.

**Cam Boru**

Borosilikat 3,3

**Cam Çubuk**

Borosilikat 3,3

**Conturax Cam Boru**

Borosilikat 3,3

**Profil Boru**

Dışı Helix Dalgalı

**Quartz Cam Boru**

1000°C a dayanıklı

**Seviye Boruları**

Borosilikat 3,3

## METAL MALZEMELER METAL MATERIALS

▶▶ METAL MALZEMELER  
METAL MATERIALS

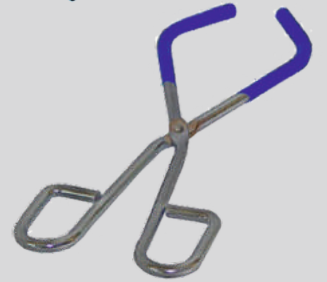



RAPTİYE - Metal Vidalı

Katalog No.

05 800 - 00001

16mm



RAPTİYE - Plastik Vidalı

Katalog No.

05 800 - 00002

13mm



RAPTİYE - Metal Vidalı

Katalog No.

05 800 - 00010

18mm



BÜRET KISKACI - Plastik

Katalog No.

05 812 - 00002



BÜRET KISKACI - Metal

Katalog No.

05 810 - 00002

7-25mm



BALON KISKACI

Katalog No.

05 810 - 00003

12-45mm



ÜÇ PARMAK KISKAÇ

Katalog No.

05 833 - 00003



DÖRT PARMAK KISKAÇ

Katalog No.

05 833 - 00004



ZİNCİRLİ KISKAÇ

Katalog No.

05 836 - 00001

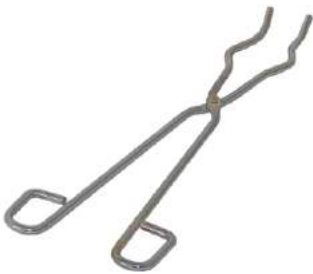

KROZE MAŞASI

Katalog No.

05 820 - 00001

Boy/mm

300mm

05 820 - 00002

350mm



BEHER MAŞASI

Katalog No.

05 821 - 00001

Boy/mm

275mm



DEMİR HALKA - Raptiyeli

Katalog No.

05 841 - 00060

Boy/mm

60 mm

05 841 - 00080

80 mm

05 841 - 00100

100 mm

05 841 - 00120

120 mm

05 841 - 00140

140 mm



SAC AYAK

Katalog No.	Boy/mm
05 842 - 00125	125mm



MOHR PENSİ

Katalog No.
05 840 - 00090



SPATÜL - Kaşıklı

Katalog No.	Boy/mm
05 851 - 00150	150mm
05 851 - 00200	200mm



BUNZEN BEKİ

Katalog No.
05 870 - 00001



İSPİRTO OCAĞI

Katalog No.	Hacim/ml
05 875 - 00150	150ml



ÖZE SAPI

Katalog No.	Boy/mm
05 852 - 00001	200mm

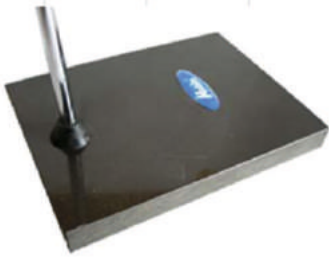

ÖZE SAPI

Katalog No.	Ebat
05 865 - 00001	200x150mm



ÜÇ AYAKLI STAND

Katalog No.	Çap
05 866 - 00012	135mm



ÜÇ ÇUBUKLU STAND

Katalog No.	Çap
05 869 - 00001	520x240mm



TÜP MAŞASI MANDAL

Katalog No.	Ebat
05 825 - 00001	180mm



TÜP MAŞASI- ÇELİK

Katalog No.	Ebat
05 825 - 00080	120mm



PİPET STANDI - Plastik

Katalog No.	Ebat
05 890 - 00001	230mm

**TÜP STANDI - PLASTİK**

Katalog No.	Delik	Çap/mm
05 885 - 00013	90 tüp	13 mm
05 885 - 00016	60 tüp	16 mm
05 885 - 00020	40 tüp	20 mm
05 885 - 00025	24 tüp	25 mm
05 885 - 00030	21 tüp	30 mm

**KRİKO**

Katalog No.	Ebat
05 843 - 00001	150x150mm
05 843 - 00002	200x200mm

**ŞİLİF KLİPSİ**

Katalog No.	NS
05 502 - 00014	14/23
05 885 - 00016	19/26
05 885 - 00020	24/29
05 885 - 00025	29/32
05 885 - 00030	45/40

**PİPET PUARI, Üç Yollu**

Katalog No.
05 880 - 00001

**SİLİKON HORTUM**

Katalog No.	İç Çap/mm	Dış Çap/mm
03 999 - 00023	8 mm	11 mm

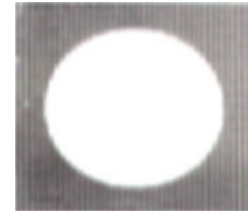
**TEL AMYANT**

Katalog No.	Ebat
05 859 - 00125	150x150 mm
05 859 - 00150	200x200 mm

**KİL ÜÇGEN**

Katalog No.	Çap/mm
05 860 - 00050	50 mm
05 860 - 00060	60 mm

**PORSELEN BUHNER HUNİSİ**

Katalog No.	Çap/mm
05 920 - 00090	90 mm
05 920 - 00100	100 mm

**PORSELEN KAYIKÇIK**

Katalog No.	Ebat
05 950 - 00001	88x13x10 mm

**PORSELEN HAVAN, Tokmaklı**

Katalog No.	Ebat
05 950 - 00001	90 mm



Beher Kısa Form.....	02	Şilifli Kroze.....	12
Erlen Dar Boyunlu.....	02	Vakumlu Kroze.....	12
Erlen Geniş Boyunlu.....	02	Selüloz Krozesi.....	12
Balon Dibi Düz.....	02	Süzme Seti.....	12
Balon Dibi Yuvarlak.....	02	Nuçe Erleni.....	13
Erlen Şilifli.....	03	Nuçe Hunisi.....	13
İyot Erleni.....	03	Su Trombu.....	13
Balon Şilifli Dibi Düz.....	03	Gaz Yıkama Şişesi.....	13
Balon Şilifli Dibi Yuvarlak.....	03	Piset.....	13
Balon İki Boyunlu.....	04	Bod Şişesi.....	13
Balon Üç Boyunlu.....	04	Vacum Trap.....	14
Balon Dört Boyunlu.....	04	Baget Termometre.....	14
Balon Beş Boyunlu.....	04	Balon Jose Pl. Kapaklı.....	16
Balon Küresel Şilifli.....	05	Balon Joje İki İşaretli.....	16
Kjeldahl Balonu.....	05	Piknometre.....	16
Distilasyon Balonu.....	05	Engler Viskozite Balonu.....	16
Engler Dstilasyon Balonu.....	05	Saybolt Viskozite Balonu.....	16
Rotapavör Balonu.....	05	La Chatalier Balonu.....	16
Balon Kalp Tipi Şilifli.....	05	Cassia Balonu.....	16
Balon Kalp Tipi İki Boyunlu.....	05	Bullu Pipet.....	17
Reaksiyon Balonu.....	06	Dereceli Pipet.....	17
Silindirik Reaksiyon Kabı Düz Şilifli.....	06	Otomatik Pipet Başlığı.....	17
Reaktör Kapağı.....	06	Hidrometri Büreti.....	17
Reaktör Kelepçesi.....	06	İmhof Hunisi.....	17
Silindirik Reaksiyon Kabı Ceketli Musluklu.....	06	Büret B Klass.....	18
Karıştırıcı Yatağı.....	07	Büret A Klass.....	18
Teflon Karıştırıcı Yatağı.....	07	Büret A Klass Amber Renk.....	18
Karıştırıcı Şaftı Çapalı.....	07	Otomatik Büret A Klass Tek Musluklu.....	18
Karıştırıcı Şaftı Açılır Kanatlı.....	07	Otomatik Büret A Klass İki Musluklu.....	18
Karıştırıcı Şaftı Teflon Kanatlı.....	07	Otomatik Büret A Klass Amber Tek Musluklu.....	18
Kpg Karıştırıcı.....	07	Otomatik Büret A Klass Amber İki Musluklu.....	18
Termometre Yuvası.....	07	Otomatik Büret Şişesi.....	19
Vezein Kabı Kısa Form.....	07	Yarı Otomatik Büret.....	19
Vezein Kabı Uzun Form.....	07	Kazan Otomatik Büreti.....	19
Tartım Kaşığı.....	07	SH Otomatik Büreti.....	19
Huni Kısa Saplı.....	07	Mezür Uzun Form.....	19
Cam Havan Tokmaklı.....	08	Mezür Kısa Form.....	19
Desikatör.....	08	Deney Tüpü.....	21
Saat Camı.....	08	Durham Tüpü.....	21
TLC Tankı.....	08	Sandrifüj Tüpü.....	21
Lam Boyama Kabı.....	08	Şilifli Tüp.....	21
Vida Kapaklı Şişe.....	08	Şilifli Tüp Dereceli.....	21
Aspiratör Şişesi.....	08	Petrol Test Tüpü.....	22
Ayırma Hunileri.....	10	Fermentasyon Tüpü.....	22
Ayırma Hunisi Armudi.....	10	Nessler Tüpü.....	22
Ayırma Hunisi Konik.....	10	Nessler Tüpü Plastik Kapaklı.....	22
Ayırma Hunisi Silindirik.....	10	Yakma Tüpü.....	22
Ayırma Hunisi Silindirik Dereceli.....	10	Erime Noktası Tayin Tüpü.....	22
Damlatma Hunisi Armudi.....	10	Kromotografi Kolunu Şilifsiz.....	24
Damlatma Hunisi Silindirik.....	11	Kromotografi Kolunu Şilifli.....	24
Damlatma Hunisi Silindirik Basınç Borulu.....	11	Kromotografi Kolunu Filtreli.....	24
Düz Soğutucu(Liebeg).....	11	Kromotografi Kolunu Balonlu.....	24
Bullu Soğutucu (Allihn).....	11	Kromotografi Kolunu Balonlu Filtreli.....	24
Sipiral Soğutucu.....	11	Puarlı Sprey.....	24
Dimrot Soğutucu.....	11		
Filtreli Kroze (Gooch).....	12		
Hunili Kroze.....	12		



Konik Kapak .....	26	Büret Kıskacı - Plastik .....	37
Plastik Vidalı Rakor .....	26	Büret Kıskacı - Metal .....	37
Konik Şilif Kıskacı Plastik .....	26	Balon Kıskacı .....	37
Küresel Şilif Kıskacı Metal .....	26	Üç Parmak Kıskaç .....	37
Hortum Bağlantısı T Tip .....	26	Dört Parmak Kıskaç .....	37
Hortum Bağlantısı Y Tip .....	26	Zincirli Kıskaç .....	37
Vidalı Adaptör .....	26	Kroze Maşası .....	37
Musluk İki Yollu .....	27	Beher Maşası .....	37
Musluk Üç Yollu .....	27	Demir Halka - Raptiyeli .....	37
Şilifli Musluk .....	27	Sac Ayak .....	38
Distilasyon Çıkış Borusu Şilifli .....	27	Mohr Pensi .....	38
Distilasyon Çıkış Borusu (Alonj) .....	27	Spatül Kaşıklı .....	38
Küçültme Adaptörü .....	27	Bunzen Beki .....	38
Gaz Giriş Borusu .....	28	İspirto Ocağı .....	38
İki Boyunlu Adaptör .....	28	Öze Sapı .....	38
Üç Boyunlu Adaptör .....	28	Üç Ayaklı Stand .....	38
Dirsek 75°C Açılı .....	28	Üç Çubuklu Stand .....	38
Dirsek 90°C Açılı .....	28	Tüp Maşası Mandal .....	38
Vakumlu Adaptör Düz .....	28	Tüp Maşası Çelik .....	38
Vakumlu Adaptör 105°C Açılı .....	28	Pipet Standı Plastik .....	38
Distilasyon Başlığı .....	28	Tüp Standı Plastik .....	39
Sıçrama Başlıklı Adaptör Düz .....	29	Kriko .....	39
Sıçrama Başlıklı Adaptör 75° Açılı .....	29	Şilif Klipsi .....	39
Distilasyon Köprüsü .....	29	Pipet Puarı .....	39
Distilasyon Köprüsü Sıçrama Başlıklı .....	29	Kil Üçgen .....	39
Distilasyon Köprüsü Termometre Şilifli .....	29	Tel Amyant .....	39
Distilasyon Köprüsü Soğutuculu, Vakum Çıkışlı .....	29	Porselen Bunher Hunisi .....	39
Bredt Distilasyon Toplama Başlığı .....	29	Porselen Kayıkçık .....	39
Bredt Distribütör .....	29	Porselen Havan Tokmaklı .....	39
Vigreux Distilasyon Kolonu .....	29	Silikon Hortum .....	39
Ekstraktör .....	31		
Soxleth Soğutucusu Bullu .....	31		
Soxleth Soğutucusu Dimrot .....	31		
Orsat Gaz Analiz Cihazı .....	31		
Ksilol Cihazı Ölçü Tüpü Musluksuz .....	31		
Ksilol Cihazı Ölçü Tüpü Musluklu .....	31		
Sudan Hafif Yağ Tayin Cihazı Ölçü Tüpü .....	32		
Sudan Ağır Yağ Tayin Cihazı Ölçü Tüpü .....	32		
Arsenik Tayin Cihazı .....	32		
Kurutma Kulesi .....	32		
Gaz Numune Alma Kabı .....	32		
Gaz Numune Alma Kabı GL 14 Borulu .....	32		
Azot (Schlenk) Balonu .....	32		
Azot (Schlenk) Tüpü .....	33		
Clevenger Cihazı .....	33		
Uçucu Yağ Tayin Cihazı .....	33		
Polenske (Lefman) Cihazı .....	33		
Kuderna Danish Cihazı .....	33		
Kipp Cihazı .....	33		
Cam Boru .....	35		
Cam Çubuk .....	35		
Conturax Cam Boru .....	35		
Profil Boru .....	35		
Quartz Cam Boru .....	35		
Seviye Boruları .....	35		
Raptiye - Metal Vidalı .....	37		
Raptiye - Plastik Vidalı .....	37		

Not:

# BORU CAM

**BORUCAM LABORATUAR VE İNŞAAT MALZEMELERİ  
SANAYİ VE TİCARET.LTD.ŞTİ**

**Adres/Adress**

Şeyh Raşit Cad. İncirlik Sok. No:25 Kat:3  
Topçular-Rami/İSTANBUL

**Telefon/Telephone**

+90 212 544 74 50 / 576 48 40

**Faks/Fax**

+90 212 544 35 68

**Email**

info@borucam.com.tr

**Web**

www.borucam.com.tr



adres



online katalog

www.borucam.com.tr